

**SerialXpress® SDX100**  
**Advanced Jitter Generation Tool for Tektronix AWG5000/B**  
**& AWG7000/B Series Waveform Generators**  
**Printed Help Document**



077-0050-03

**Tektronix**



**SerialXpress® SDX100**  
**Advanced Jitter Generation Tool for Tektronix AWG5000/B &**  
**AWG7000/B Series Waveform Generators**  
**Printed Help Document**

Copyright © Tektronix. All rights reserved. Licensed software products are owned by Tektronix or its subsidiaries or suppliers, and are protected by national copyright laws and international treaty provisions.

Tektronix products are covered by U.S. and foreign patents, issued and pending. Information in this publication supersedes that in all previously published material. Specifications and price change privileges reserved.

TEKTRONIX and TEK are registered trademarks of Tektronix, Inc.

SerialXpress® SDX100 is a registered trademark of Tektronix, Inc.

MATLAB®. Copyright 1984 - 2007 The MathWorks, Inc.

SerialXpress Online Help, part number 076-0112-03.

### **Contacting Tektronix**

Tektronix, Inc.  
14200 SW Karl Braun Drive  
P.O. Box 500  
Beaverton, OR 97077  
USA

For product information, sales, service, and technical support:

- In North America, call 1-800-833-9200.
- Worldwide, visit [www.tektronix.com](http://www.tektronix.com) to find contacts in your area.

# Table of Contents

General Safety Summary .....	v
<b>Introduction</b>	
Welcome .....	1
Free Trial .....	1
Related Documentation .....	1
Conventions .....	1
Feedback .....	2
<b>Getting Started</b>	
Minimum System Requirements .....	3
Ordering SerialXpress .....	3
Supported Instruments .....	3
Installation .....	4
Connection Setups	
Setup for Base Data Signal Generation .....	4
<b>Operating Basics</b>	
About Basic Operations .....	7
Overview of the Software .....	8
Starting the Software .....	9
Exiting the Software .....	9
File Name Extensions and Directories .....	10
Menus and Toolbars	
Menu Bar .....	11
Standard Toolbar .....	15
Status Bar .....	16
Waveform List .....	16
Toolbar Options and Dialog Boxes	
Calibration .....	18
Overview .....	20
Find Instruments .....	21
Graph Setup .....	21
Compile .....	23
Compile Settings .....	23
Batch Process .....	26
On/Off .....	29
Run .....	29
Option Installation .....	29

Restore Default Setup .....	30
Open Setup .....	31
Save Setup .....	31
Save Setup As .....	31
Import from File .....	31
Import from Tektronix Oscilloscope.....	31
PRBS Editor.....	33

## Creating a Signal

Base Pattern	
Setting the Base Pattern .....	35
Creating the Base Data .....	40
Calibration for Base Pattern Signals.....	43
Transmitter	
Setting Jitter Parameters .....	45
Channel/Cable	
Setting ISI and S-Parameter Filter Parameters .....	48

## Instrument Control

AWG .....	51
Oscilloscope.....	54

## Graphing

Zooming Graphs .....	57
Rise/Fall .....	58
Simulated Data Signal .....	59
Random Jitter .....	60
Periodic Jitter .....	61
Total Jitter .....	62
Normal Eye.....	63
Eye DPO.....	64
TIE .....	65

## Reference

Error Messages.....	67
Shortcut Keys .....	69
PRBS Editor Starting Values .....	70
AWG Specifications.....	70
Interleave .....	70
Zeroing.....	72
Parameter Definitions .....	73
About Calibration.....	73

---

About Spread Spectrum Clocking (SSC) .....	74
Custom SSC .....	74
About Inter Symbol Interference (ISI)/ISI Scaling .....	74
DPOJet Settings.....	75
White Noise .....	77
Periodic Jitter - Sample Test Results .....	77
Main Menu Default States .....	78
Default Values.....	80

## Index





# General Safety Summary

Review the following safety precautions to avoid injury and prevent damage to this product or any products connected to it.

To avoid potential hazards, use this product only as specified.

*Only qualified personnel should perform service procedures.*

While using this product, you may need to access other parts of a larger system. Read the safety sections of the other component manuals for warnings and cautions related to operating the system.

## To Avoid Fire or Personal Injury

**Connect and Disconnect Properly.** Do not connect or disconnect probes or test leads while they are connected to a voltage source.

**Ground the Product.** This product is indirectly grounded through the grounding conductor of the mainframe power cord. To avoid electric shock, the grounding conductor must be connected to earth ground. Before making connections to the input or output terminals of the product, ensure that the product is properly grounded.

**Observe All Terminal Ratings.** To avoid fire or shock hazard, observe all ratings and markings on the product. Consult the product manual for further ratings information before making connections to the product.

**Power Disconnect.** The power cord disconnects the product from the power source. Do not block the power cord; it must remain accessible to the user at all times.

**Do Not Operate Without Covers.** Do not operate this product with covers or panels removed.

**Do Not Operate With Suspected Failures.** If you suspect that there is damage to this product, have it inspected by qualified service personnel.

**Avoid Exposed Circuitry.** Do not touch exposed connections and components when power is present.

### Terms in this Manual

These terms may appear in this manual:



**WARNING.** *Warning statements identify conditions or practices that could result in injury or loss of life.*

---



**CAUTION.** *Caution statements identify conditions or practices that could result in damage to this product or other property.*

---

## Welcome

SerialXpress is a tool for the high speed serial data industry that takes an input pattern and creates pre-distorted waveforms to test a device's conformance to SATA, HDMI, Display Port, PCI Express, SAS, Fiber channel, and USB standards.

## Free Trial

SerialXpress supports **Option SSC** that enables SSC parameters and **Option ISI** that enables ISI options. You can transfer or save the data for ten trials. When the trial expires, you cannot transfer or save the waveform unless you enable the function with an option (license) key.

For more details, refer to [Option Installation \(see page 29\)](#).

## Related Documentation

In addition to this SerialXpress Online Help, the following documentation is included with the software:

- *SerialXpress Installation Manual* (Tektronix part number 077-0049-XX). The installation manual has information about installing and upgrading the software.
- *SerialXpress User Manual* (Tektronix part number 077-0050-XX). The user manual is adapted from the online help and is available in PDF format.
- *SerialXpress Quick Start User Manual* (Tektronix part number 077-0064-XX). The quick start user manual has information about using the software and application examples.
- *SerialXpress Programmer Online help* (Tektronix part number 076-0166-XX). The programmer online help has information on how to use commands for remotely controlling your instrument.
- *SerialXpress Programmer Manual* (Tektronix part number 077-0144-XX). The programmer manual is adapted from the programmer online help and is available in PDF format.

## Conventions

The online help uses the following conventions:

- When steps require a sequence of selections using the software interface, the ">" delimiter marks each transition between a menu and an option. For example, **File > Save**.
- DUT refers to the Device Under Test.

- Three dots (...) following a menu item indicates that the menu item will open a submenu or a dialog box.
- The terms "waveform" and "signal" are used interchangeably.
- The term AWG refers to a Tektronix Arbitrary Waveform Generator.

## Feedback

Tektronix, Inc.

14200 SW Karl Braun Drive

P.O. Box 500

Beaverton, OR 97077

USA

For product information, sales, service, and technical support:

- In North America, call 1-800-833-9200.
- Worldwide, visit [www.tektronix.com](http://www.tektronix.com) to find contacts in your area.

## Minimum System Requirements

The minimum requirements of the SerialXpress application are listed in the following table:

**Table 1: Minimum system requirements**

<b>Supported OS</b>	Windows XP Professional Service Pack 2.1 Windows Vista Business Edition (English Language)
<b>Minimum Requirements</b>	2.0 GHz or higher 1 GB RAM 2 GB free disk space 1024 x 768 display resolution with 120 dpi font size

## Ordering SerialXpress

SerialXpress can be ordered as follows:

**Table 2: Ordering SerialXpress**

<b>Software packages and options</b>	<b>Description</b>
SDX100	Jitter generation software package for AWG (includes option key).
Option ISI	S-Parameter and ISI creation option (requires SDX100 as prerequisite).
Option SSC	Spread Spectrum Clock addition option (requires SDX100 as prerequisite).
SDXUP	Base Software upgrade for SDX100.
Option ISI	Upgrade to include S-Parameter and ISI creation option for SDX100.
Option SSC	Upgrade to include Spread Spectrum Clock option for SDX100.

## Supported Instruments

SerialXpress supports the following instruments:

- AWG5002, AWG5002B
- AWG5004, AWG5004B
- AWG5012, AWG5012B
- AWG5014, AWG5014B

- AWG7051
- AWG7052
- AWG7101
- AWG7102
- AWG7121B
- AWG7122B
- AWG7061B
- AWG7062B

## Installation

An installation wizard installs SerialXpress. If you have not installed MATLAB Runtime version 7.6, TekVISA version 3.3.2.7, and .NET 2.0, you will be notified during installation. You can install SerialXpress from the application CD Browser. You can also install TekVISA, .NET, and MATLAB Runtime from the CD Browser. You can cancel the installation any time during the process.

---

**NOTE.** You can download the TekVISA software from [www.tektronix.com/software](http://www.tektronix.com/software). You can also install TekVISA from the path \TekVISA on the application CD.

---

For details on how to install the application, refer to the *SerialXpress Installation Manual* (Tektronix part number 077-0049-XX) available as a PDF on the CD-ROM.

You can uninstall in either of these two ways:

- From **Start > All Programs > Tektronix SerialXpress > Uninstall SerialXpress**.
- From Add/Remove programs in Control panel.

## Setup for Base Data Signal Generation

1. Start the SerialXpress installed on the Arbitrary Waveform Generator (AWG).
2. Select the **Standard** and **Pattern** type from the **Base Pattern** tab.
3. Make connections as shown in the following figure:
  - Connect the AWG Ch1 Analog Output to the DUT where the base data waveform must be fed.
  - When using the Interleave mode, the output should be taken from Interleave output as shown.

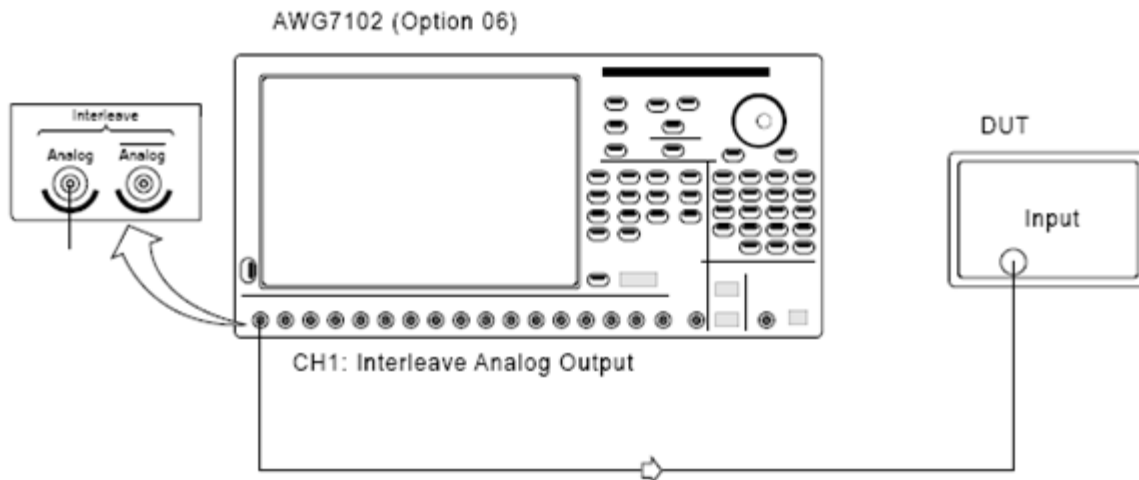

4. Click **Compile** in the toolbar. The waveform is compiled according to the default settings in the **Compile Settings** dialog box. The compiled waveform is displayed in the Waveform List. This waveform will be transferred to the AWG channel (Ch1) and can also be seen in the **Instrument Control > AWG** tab.
5. Click **On/Off** to turn on Ch1.
6. Click **Run** to generate the waveform on the AWG.

For more details, refer to [Calibration for Base Pattern Signals \(see page 43\)](#) and [Find Instruments \(see page 21\)](#).





## About Basic Operations

The basic operations section describes the application, tells how to start the application, use the menus and toolbars, and describes the dialog boxes.

In this online help, all menu selections are indicated with Menu name and Menu options separated by “>”. You can access a command or a menu option in more than one way. Several main menu options are available in a toolbar that you can use instead of selecting the option from the main menu. Shortcut menus, which open with a right-click, are provided for renaming, deleting waveforms, showing graphs, saving data, importing data from a Tektronix oscilloscope, and transferring a waveform to an AWG.

Some dialog boxes also have a **Help** button that displays help for that dialog box.

Detailed operations and parameters are described in the sections on Base Pattern, Transmitter, and Channel/Cable. The Reference section lists Error Messages, Shortcut Keys, Default states/values, Table of Measurements, and additional information on Calibration, Interleave, Noise, Pseudo Random Binary Sequence (PRBS), Spread Spectrum Clocking (SSC), and Inter Symbol Interference (ISI).

The following figure shows the SerialXpress screen, the menu, the toolbar, and other elements of the display.

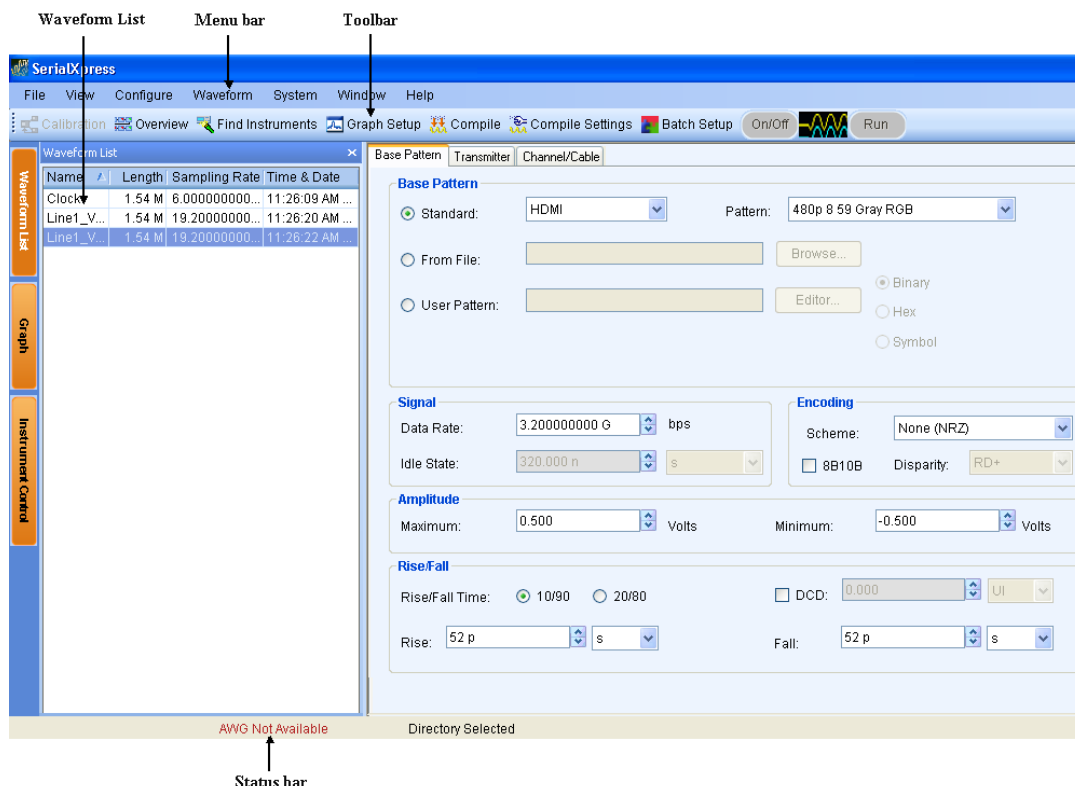

## Overview of the Software

SerialXpress is a tool for the high speed serial data industry that takes an input pattern and creates pre-distorted waveforms to test a device's conformance to SATA, SAS, HDMI, Display Port, Fiber Channel, USB, and PCI-Express standards.

### Key Features

- **Jitter Generation:** Up to four different sinusoidal jitters with different amplitudes, frequencies and phases can be added to a base pattern. Two independent band-limited random jitters can also be added to the base pattern.
- **SSC Addition:** SSC can be added with precisely controlled profile, spread, deviation, modulation, and df/dt.
- **Pre/De-emphasis and Noise:** Many standards such as PCI-E require the output waveform to be pre/de-emphasized. SerialXpress allows easy addition of pre/de-emphasis with all other jitter parameters. Vertical noise can be added at both near and far ends of the channel.
- **Inter Symbol Interference (ISI) Creation:** SerialXpress allows you to create ISI either by entering it directly or from an S-parameter file captured either from a Tektronix sampling oscilloscope or a Vector Network Analyzer. The S-parameter can be directly convolved with the base pattern to recreate the channel characteristics. By applying an inverse filter, the effects of the channel can be de-embedded from the circuit. The ISI within the S-parameter can be scaled upward or downward easily altering the characteristics of the channel.
- **Base Pattern:** SerialXpress is bundled with several sample patterns for various standards like SATA, Display Port, SAS, PCI-E, HDMI, Fiber Channel, and USB. Patterns can also be directly entered in a Binary, Hex, or Symbol editor, or loaded from a file.
- **Idle State:** Standards like SATA call for OOB signaling which requires an idle state followed by a burst. You can directly create this idle state without using additional power dividers. Noise can also be added to these idle state waveforms.
- **Calibration:** SerialXpress has a built-in calibration routine, which controls a Tektronix oscilloscope and calibrates the output of a Tektronix arbitrary waveform generator (AWG) for periodic jitter and random jitter.
- **Bandwidth expansion filter:** The bandwidth of an AWG can be expanded further by applying the bandwidth expansion filter which compensates for DAC roll-off. For example, when used with an AWG7122B with option 06, the bandwidth expansion filter compensates for the DAC roll-off at higher frequencies, thereby extending the bandwidth up to 9.6 GHz. This helps in improving the rise time.
- **Batch Processing:** When more than one pattern needs to be synthesized, you can use batch processing to create multiple waveforms with a combination of random and sinusoidal jitter with a maximum of four different frequencies.
- **Overview Window:** All jitter parameters can be switched on or switched off from the overview window.

## Starting the Software

From the Start menu, click **All Programs > Tektronix SerialXpress > SerialXpress**. You can also double-click the **SerialXpress** shortcut on the desktop.

You can use the application in three modes:

- When SerialXpress is started with the AWG software running, it is called online mode. In this case, the SerialXpress automatically detects the AWG software. You can transfer data directly to the AWG software.
- When SerialXpress is started without the AWG software running, it is called offline mode. You can transfer data to the AWG offline software.
- When SerialXpress is started on the PC without the AWG software running, SerialXpress does not detect the AWG software. In this case, you cannot transfer data to the AWG (although you can create and store the waveform for later use).

---

**NOTE.** *The AWG software refers to the AWG memory manager and AWG Virtual GPIB parser executables. The AWG user interface application and other executables are not necessary but they may also be running.*

---

## Exiting the Software

Select **File > Exit** to exit the application. If you have not saved the waveforms, you are prompted to do so. This option is always enabled.

## File Name Extensions and Directories

The application uses the following file name extensions:

**Table 3: File name extensions and their descriptions**

File name extension	Description
.csv	Ascii file containing Comma Separated Values. This file format may be read by any ascii text editor (such as Microsoft Notepad) or may be imported into spreadsheets such as Microsoft Excel.
.sxs	XML (Extensible Markup Language) file containing setup information for creating a waveform.
.wfm	Binary file containing an oscilloscope waveform record in a recallable, proprietary format.
.sxc	Custom format binary file containing the calibration related information.
.s1p	Files that define 1-port, 2-port, and 4-port S-Parameters.
.s2p	
.s4p	

The application uses the following directories:

**Table 4: Directory names and their descriptions**

Directory	Description
<Application installation path>\Tektronix\SerialXpress\System	Contains the software executables, DLL files, sample patterns, and touchstone files.
<Application installation path>\Tektronix\SerialXpress\Documentation	Contains the related documentation as text and PDF files.
<Application installation path>\Tektronix\SerialXpress\Samples	Contains sample waveform files.
<Application installation path>\Tektronix\SerialXpress\Samples\SATA	Contains sample base data files for patterns such as MFTP, HFTP, and others in txt format.
<Application installation path>\Tektronix\SerialXpress\Samples\SAS	Contains sample base data files for patterns such as JTPAT +ve disparity, JTPAT -ve disparity, and others in txt format.
<Application installation path>\Tektronix\SerialXpress\Samples\HDMI	Contains sample base data files for patterns such as 480p 8 59 Gray RGB, 720p 8 60 Gray RGB, and others in txt format.
<Application installation path>\Tektronix\SerialXpress\Samples\DisplayPort	Contains sample base data files for patterns such as DP Training sequence2 960, CJTPAT, and others in txt format.
<Application installation path>\Tektronix\SerialXpress\Samples\PCI-Express	Contains sample base data files for patterns such as Compliance Pat in txt format.

**Table 4: Directory names and their descriptions (cont.)**

Directory	Description
<Application installation path>\Tektronix\SerialXpress\Samples\Fiber Channel	Contains sample base data files for patterns such as CJTPAT, JTPAT, and others in txt format.
<Application installation path>\Tektronix\SerialXpress\Samples\General	Contains sample base data files for patterns such as Clock, PRBS7, and others in txt format.
<Application installation path>\Tektronix\SerialXpress\Samples\USB	Contains sample base data files for patterns such as MinAdd1N and MinAdd1P in txt format.
<Application installation path>\Tektronix\SerialXpress\Samples\User Defined	This folder is empty. You can store the sample files that you define in this folder.
<Application installation path>\Tektronix\SerialXpress\Samples\Touchstone	Contains sample touchstone files used with the S-Parameter Filter.

## Menu Bar

The SerialXpress menu has the following items:

- File

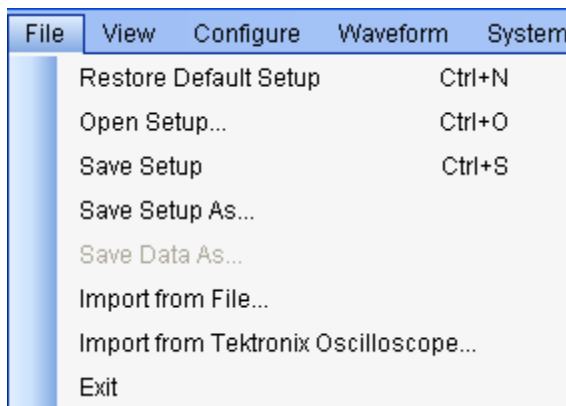

Use the File menu to:

- Restore the default setup for the current active parameters.
- Open a saved setup. The supported file is in `sxs` format.
- Save a setup in the `sxs` format.
- Save a setup under another name in the `sxs` format.
- Import from file. The supported file is in DTG (Data Timing Generator) format.
- Import data from a Tektronix oscilloscope.
- Save data in `wfm` format.
- Exit the application.

## ■ View

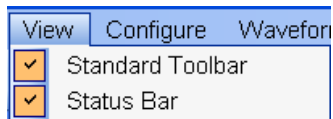

Use the View menu to:

- View or hide the toolbar. If the toolbar is hidden before closing the application, it remains hidden when the application is opened again.
- View or hide the status bar. If the status bar is hidden before closing the application, it remains hidden when the application is opened again.

## ■ Configure

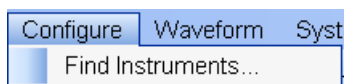

Use the Configure menu to:

- Find instruments that are connected on the network.

## ■ Waveform

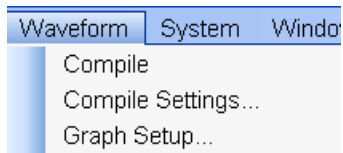

Use the Waveform menu to:

- Compile a new waveform file based on current settings.
- Open the Compile Settings dialog box and define the compile options.
- Open the Graph Setup dialog box and define the graph setup.

## ■ System

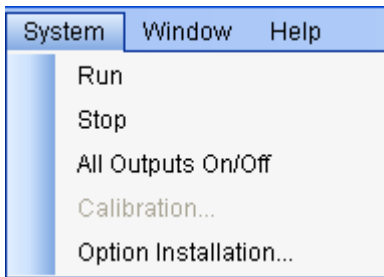

Use the System menu to:

- Set the AWG run mode to on.
- Set the AWG run mode to off.
- Turn all the channel outputs to on or off on the AWG.
- Open the Calibration dialog box and set the parameters to calibrate the waveform.
- Open the Option Installation dialog box and enable the function with an option (license) key.

---

**NOTE.** All these menu items except **Option Installation...** are enabled when SerialXpress is running in the online mode.

---

## ■ Window

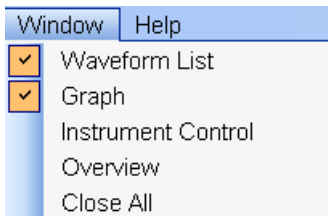

- View or hide the waveform list.
- View or hide the graph window.
- View or hide the instrument control window.
- Open the Overview window.
- Close all windows.



- Help

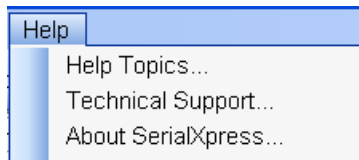

Use the Help menu to:

- Open the online help.
- Display technical support contact information on the Tektronix Web site.
- Display information about the application, such as version number.

## Standard Toolbar

Select **View > Standard** toolbar to hide or show the toolbar. The toolbar is always displayed by default.



The Standard toolbar has the following options that you can select:

- [Calibration \(see page 18\)](#)
- [Overview \(see page 20\)](#)
- [Find Instruments \(see page 21\)](#)
- [Graph Setup \(see page 21\)](#)
- [Compile \(see page 23\)](#)
- [Compile Settings \(see page 23\)](#)
- [Batch Setup \(see page 26\)](#)
- [On/Off \(see page 29\)](#)
- [Run \(see page 29\)](#)

## Status Bar

Select **View > Status Bar** to hide or show the status bar. The status bar shows the selected application and the AWG mode. The status bar is always displayed by default.

When SerialXpress is running on the PC without AWG software, the status bar shows "AWG Not Available".

When SerialXpress is running with AWG software in the online mode, the status bar shows "Mode : Online Model: xxxxx", where "xxxxx" is the instrument model number.

When SerialXpress is running with AWG software in the offline mode, the status bar shows "Mode : Offline".

When Batch Process is enabled in the **Compile Settings** dialog box, the status bar shows "Batch Compile Selected". When Batch Process is disabled, the status bar does not show a message.

## Waveform List

Select **Window > Waveform List** to view the waveform list. Waveform list is a floating window that displays a list of all the waveforms. It can be moved anywhere in the display area. By default it is always displayed and opens in the leftmost area of the display window.

After you select a pattern to generate and set the parameters for it, you must compile it to create the data. Once you compile a waveform (using **Compile** from the toolbar), waveform data is created and added to the waveform list. The Waveform list displays the Name, Length, Sampling Rate, and Time and Date of the waveform data.

To save a waveform that is available in the list, select the waveform and select **File > Save Data As...** The compiled waveform is saved as a data file (wfm) in the specified location. If there is no data to save, then the **Save Data As...** option is disabled.

---

**NOTE.** *If you close the application without saving the compiled waveform, the waveform is lost. You can compile the waveform again from the setup, if you have saved the setup using **File > Save Setup or Save Setup As...***

---

You can select the following options from the shortcut menu:

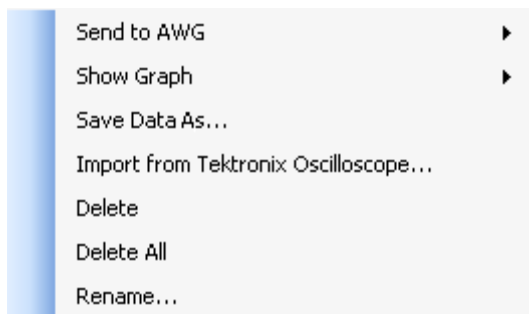

**Table 5: Shortcut menu options and their description**

Selection	Description
Send to AWG	Enabled only if the SerialXpress is running with AWG software in the online mode and when a waveform is selected. Sends the selected waveform data to a Tektronix AWG. Select the channel to which to send the data. The number of channels and their state in the list depends on the model of AWG and its current settings.
Show Graph	Enabled only when a waveform is selected. You can select Simulated Data Signal, Normal Eye, and Eye DPO graphs from this option.
Save Data As...	Enabled only when a waveform is selected. Saves the selected waveform data as a wfm file under the specified name and location.
<a href="#">Import from Tektronix Oscilloscope... (see page 31)</a>	Imports data from a Tektronix oscilloscope that is connected to the instrument or PC on which the application is running.
Delete All	Enabled only when one or more waveforms are available in the Waveform List. Deletes all the waveforms shown in the waveform list permanently.
Delete	Enabled only when a waveform is selected. Deletes the selected waveform permanently.
Rename...	Enabled only when a waveform is selected. Opens a dialog box that allows you to enter a waveform name. When a waveform name already exists, an error message is displayed.  <b>NOTE.</b> All the properties of the waveform remain the same except the waveform name.

You can select multiple contiguous and non-contiguous waveforms using the **Shift** and **Ctrl** keys, respectively. When you select multiple waveforms in the waveform list, the **Show Graph**, **Save Data As...**, and **Rename...** options are disabled. Selecting multiple waveforms and the **Delete** option deletes all the selected waveforms.

## Calibration

Click **System > Calibration...** or **Calibration** in the toolbar to calibrate the waveform. This option is always enabled. You can calibrate parameters like random jitter and periodic jitter.

---

**NOTE.** Update the TekVISA resource manager before performing calibration. Only DPO70000 and DSO70000 series oscilloscopes are listed.

---

You must select a base data file, and set the data rate and sampling rate for calibration. To use SSC, enable SSC and set the values for the SSC parameters before starting calibration.

Calibration can be carried out by varying the Pj and Rj values. Parameters such as data rate, base data file, sampling rate, SSC on/off, and rise/fall time should not be changed. If you change any of these parameters, you must recalibrate the setup.

You can save the calibration data as an **sxc** file.

A table displays a list of instruments on the network. The instrument model, status, connection type, and name are shown but they are not editable. The following buttons are available:

**Table 6: Instrument setup buttons and their description**

Button	Description
Connect	Connects to the instrument selected in the table and updates the status to Connected in the table.
Disconnect	Disconnects the instrument selected in the table and updates the status in the table.
Test Connection	Returns the current status of the selected instrument in the table and displays the status as Connected (in green) or Not Connected (in red).
Calibrate	Starts calibration. The calibration status is displayed at the bottom of the dialog box.

Click **OK** to apply the calibration data with “**Apply calibration**” option enabled in the **Calibration Setup** dialog box. Click **Cancel** to abort calibration.

The Calibration Settings are as follows. All the calibration settings that are set in SerialXpress are updated on the connected instrument.

**Table 7: Calibration setup options and their description**

<b>Selection</b>	<b>Description</b>
DPOJet Settings	<p>Selecting Automatic sets up the DPOJet application on the connected oscilloscope in the most optimal way. This is useful for the simplest of calibrations.</p> <p>Select Manual to set up DPOJet application on the connected oscilloscope for measuring SSC. When SSC is enabled, you need to set up the filter parameters and PLL clock.</p> <p>For more details, refer to <a href="#">DPOJet Settings. (see page 75)</a>.</p>
Save	Saves the calibration setup file as an sxc file. You can also select the path where the file is saved.
Load	Loads a previously saved sxc file and displays the values in the fields.
Apply calibration	Enables calibration. When disabled, calibration data will not be applied. You have to either load the calibration file from disk using the "Load" option or recalibrate the application.
Enable SPC calibration on oscilloscope	Enables SPC calibration on the connected oscilloscope.
Enable AWG channel calibration	Enables AWG channel calibration.

The status of calibration process is shown at the bottom of **Calibration** dialog box.

Click **Calibrate** to start the calibration process.

At the end of the process, save the calibration data in a file specified in the file path. You can use **Browse** to select a previously saved calibration file. Click **Apply** for the changes to take effect without recalibrating.

## Overview

Click **Window > Overview** to view the overview window. A block view of the active waveform settings appears in a new window. This window is a floating window and can be moved around the screen. Each larger grouping in the diagram corresponds to a tab. This option is always enabled.

The Overview window has the following blocks:

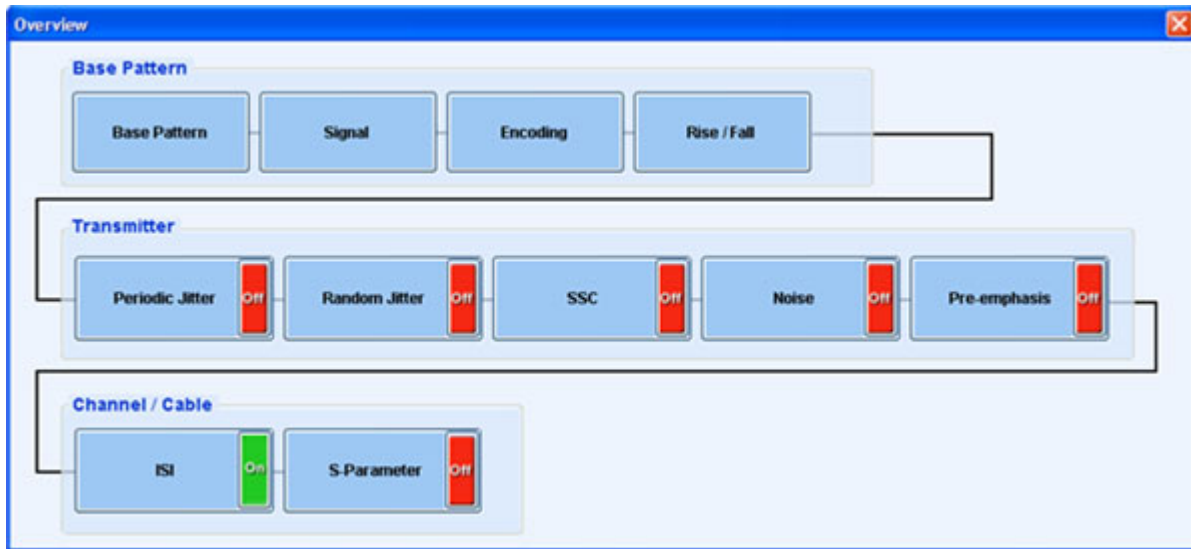

The On/Off button in the right side of each block corresponds to the check box for the group on the settings tab. When the button is Off, the previous settings are retained but not used for Compile operation.

- If the group does not have a check box, then On/Off buttons are not displayed on the block.
- If the check box is disabled, the button text is Off (red).
- If the check box is enabled, the button is On (green). The button on the block and the check box in the group box are linked—if you change one, the change is reflected in the other.

For **Periodic Jitter**, if any of the periodic jitter parameters are selected in the **Base Pattern** tab, then the corresponding button is On in the **Overview** dialog box.

When you click any block in the **Overview** dialog box, the corresponding parameter is highlighted in the application and the **Overview** dialog box closes.

## Find Instruments

Click **Configure > Find Instruments...** to view the find instruments window. You can find instruments on the network and connect to them. This option is always enabled.

**Table 8: Find instruments options and their description**

Button	Description
Connect	Connect to the instrument selected in the table. Connect is enabled by default if an instrument is highlighted in the table; disabled if no instrument is highlighted.
Disconnect	Disconnect the connected instrument. Enabled only if highlighted instrument is connected.
Refresh	Refresh the list of instruments.
<a href="#">Import... (see page 31)</a>	Open the Import from Tektronix Oscilloscope dialog box to select a file to import.

Click **Connect** to connect to the selected instrument. The Status provides the current status during the refresh operation: Searching Instruments or Ready.

## Graph Setup

Click **Waveform > Graph Setup...** to view the graph setup window. This option is always enabled.

Graphs are created and updated as part of the Compile operation. You can display any two plots at a time. The plots cannot be edited or saved. If you change any of the parameter values, you must compile again to display the changes in the plot. You can maximize one plot at a time and zoom a selected area of interest.

The application allows you to select the types of graphs before creating them. The graphs are displayed as a set in a small window (for preview). At any time, a maximum of two graphs can be displayed in the small view.

To specify the graphs to create, click **Graph Setup** in the toolbar or **Waveform > Graph Setup** from the menu bar. The Graph Setup dialog box opens.

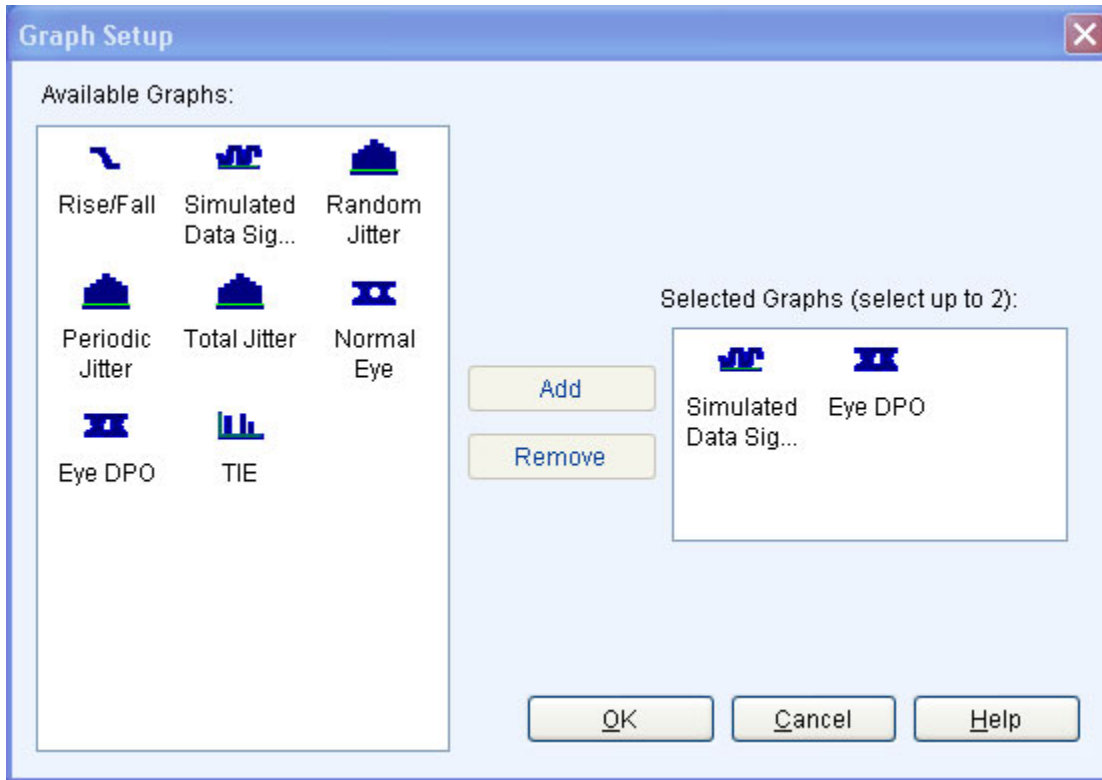

Follow these steps to select the graphs to create:

- Highlight a graph from **Available Graphs**. Click **Add** to add the graph to the **Selected Graphs** area or drag and drop the graph to the Selected Graphs area.

You can select the plots to display. SerialXpress supports the following plots:

- [Rise/Fall \(see page 58\)](#)
- [Simulated Data Signal \(see page 59\)](#)
- [Random Jitter \(see page 60\)](#)
- [Periodic Jitter \(see page 61\)](#)
- [Total Jitter \(see page 62\)](#)
- [Normal Eye \(see page 63\)](#)
- [Eye DPO \(see page 64\)](#)
- [TIE \(see page 65\)](#)

---

**NOTE.** By default, **Simulated Data Signal** and **Eye DPO** are selected. Once two graphs are added to **Selected Graphs**, the application will not allow you to add any more graphs. You must remove a graph before you can add another graph.

---



To remove a graph, highlight a graph in **Selected Graphs** and click **Remove** in the **Graph Setup** dialog box or **Delete** on the keyboard.

- Click **OK** to view the graphs. The graphs are displayed in the **Graph** tab.

## Compile

Click **Waveform > Compile** to compile a currently active waveform.

The waveform is compiled and displayed in the Waveform List. You can save the waveform data as a wfm file using the [Waveform List \(see page 16\)](#) shortcut menu. This option is not enabled when compilation is in progress.

## Compile Settings

Click **Waveform > Compile Settings...** to specify compilation settings for the currently active waveform setup. This option is always enabled. This dialog box is displayed.

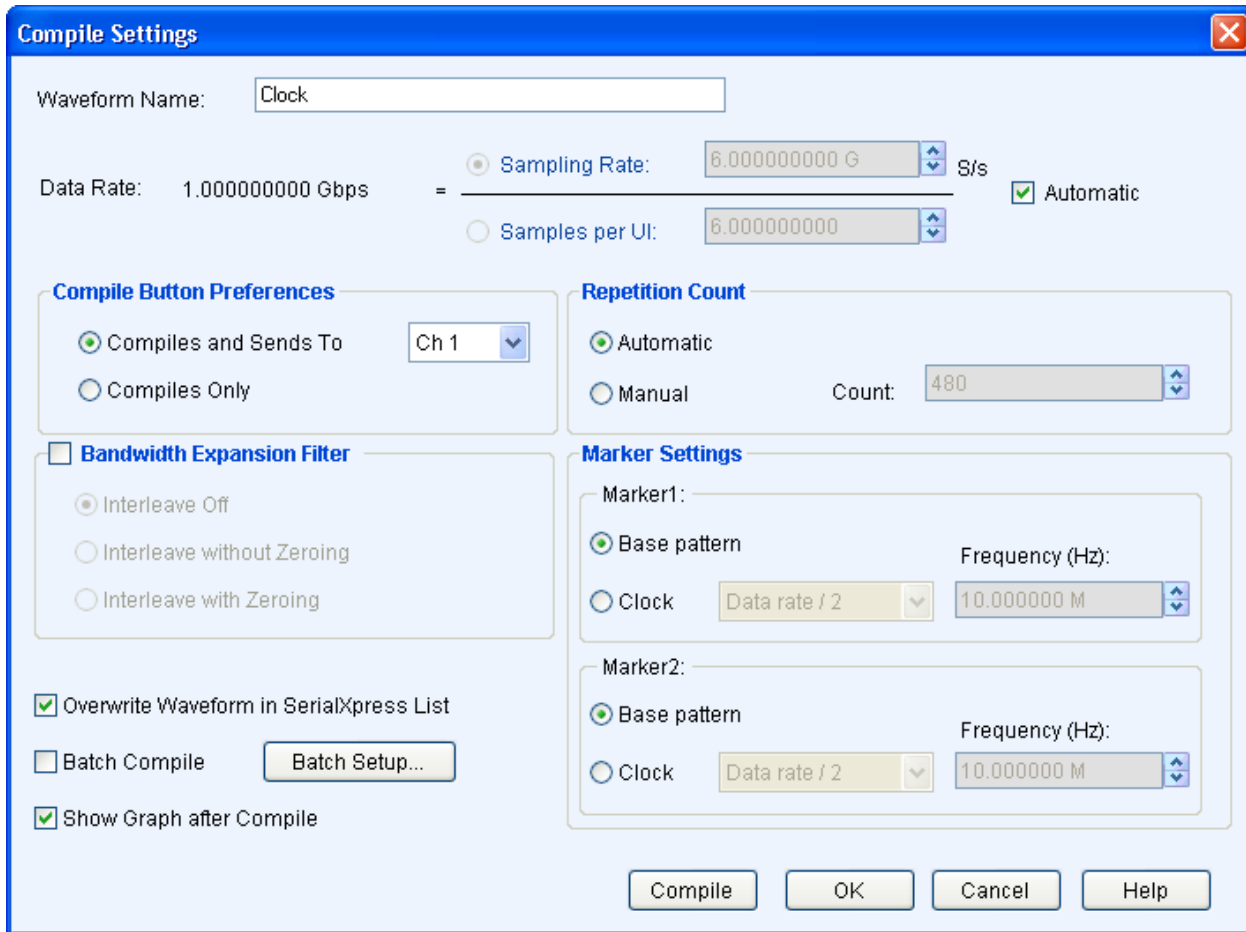

**Table 9: Compile settings options and their description**

Selection	Description
Waveform Name	Enter the waveform name. The waveform name is same as the pattern selected, except for patterns such as <b>User Defined</b> . You can change the waveform name either in the <b>Compile Settings</b> dialog box or by using <b>Rename</b> option from the waveform list shortcut menu.

**Table 9: Compile settings options and their description (cont.)**

Selection	Description
Automatic	<p>Enable this to calculate the sampling rate. By default, this is enabled. When disabled, you can change the sampling rate or samples per UI.</p> <p>In the offline mode, the sampling rate of the waveform is 24 GS/s. In the online mode, the sampling rate of the waveform depends on the maximum sampling rate of the instrument.</p> <p>The minimum and maximum values of samples per UI are 2 and 240 respectively. When the value of samples per UI is out of range, the sampling rate is automatically adjusted to achieve the specified data rate.</p>
Data Rate	This option is not editable. The data rate is equal to the ratio of Sampling Rate and Samples per UI.
Sampling Rate	Enter the sampling rate (in S/s) of the waveform to compile.
Samples per UI	Enter the samples per UI of the waveform to compile.
<b>NOTE.</b> <i>If you change the sampling rate or samples per UI value, the rise/fall time values also changes.</i>	
<b>Compile Button Preferences</b>	
Compiles and Sends To	Select this to compile and send the waveform to the specified channel. By default, Ch1 is selected. This option is enabled only when the SerialXpress is running in the online mode.
Compiles Only	Select this to compile the waveform without sending it to the AWG. The compiled waveform is displayed in the waveform list.
<b>Repetition Count <sup>1</sup></b>	
Automatic	<p>When enabled (default), the repetition count is set to automatic.</p> <p>The repetition count is calculated based on the Pj, Rj, and SSC frequency values.</p>
Manual	<p>Enable this to manually set the repetition count.</p> <p>The minimum and maximum values depend on the following parameters:</p> <ul style="list-style-type: none"> <li>■ Input pattern size (that is, total number of bits)</li> <li>■ Current SPUI (Samples Per UI) value</li> </ul> <p>The maximum value is calculated depending on the memory availability.</p> <p>The minimum and default values are calculated depending on the minimum number of samples required by the AWG (960 samples), Pj, Rj, and SSC frequency values.</p>
<b>Bandwidth Expansion Filter <sup>2</sup></b>	
Interleave Off	Select <b>Bandwidth Expansion Filter</b> to enable this option. This option is available only when the sampling rate is less than 12 GS/s.

**Table 9: Compile settings options and their description (cont.)**

<b>Selection</b>	<b>Description</b>
Interleave without Zeroing	Select this to apply the bandwidth expansion filter if zeroing is off. This option is available only when the sampling rate is greater than or equal to 12 GS/s.
Interleave with Zeroing	Select this to apply the bandwidth expansion filter if zeroing is on. This option is available only when the sampling rate is greater than or equal to 12 GS/s.
<b>Marker Settings</b>	
Base pattern	Select this option for the marker output to be the same as the base pattern.
Clock	Select this option for the marker output to be same as the selected clock type. You can select the clock from the available options.  If you have selected the clock as <b>User Defined</b> , you can change the frequency.  <b>NOTE.</b> <i>If the frequency that you have entered is not a factor of the data rate, the marker may not synchronize with the rising edge of each data bit.</i>
Overwrite Waveform in SerialXpress List	Select this to overwrite a waveform in the list with the compiled waveform. When disabled, you are prompted that a file of the same name exists.
<a href="#">Batch Process (see page 26)</a>	Select this to activate batch compilation.
Show Graph after Compile	Select this to display the graphs after compilation. The compiled graph is displayed using <b>Graph Setup</b> dialog box. When disabled, no plot is displayed after compilation and the compilation time is reduced.

- <sup>1</sup> Repetition count determines the number of times the input pattern repeats before generating the waveform. This allows you to determine the optimum waveform size for best results.
- <sup>2</sup> The bandwidth expansion filter is used to improve the performance of the AWG when the rise time is very high. For better use of the bandwidth expansion filter, set the rise time to less than 80 ps.

**NOTE.** *When **Automatic** option is enabled, the **Sampling Rate** and **Samples per UI** options are disabled.*

The **Compile and Sends To** and **Compile Only** options are disabled when SerialXpress is in the offline mode. Click **Compile** to compile the waveform. The compiled waveform is displayed in the waveform list.

## Batch Process

Click **Batch Setup** from the toolbar or **Compile Settings > Batch Process > Batch Setup...** to set up the batch process. This option is disabled by default.

Batch Process creates multiple waveforms with a combination of random jitter and periodic jitter with a maximum of four different frequencies with user-defined parameter increments.

Clicking **Compile** starts batch compilation when **Batch Process** is enabled. This dialog box is displayed upon clicking **Batch Setup**.

---

**NOTE.** When you navigate the batch process through **Compile Settings**, the **Waveform Name**, **Compile Button Preferences**, and **Show Graph after Compile** options are disabled.

---

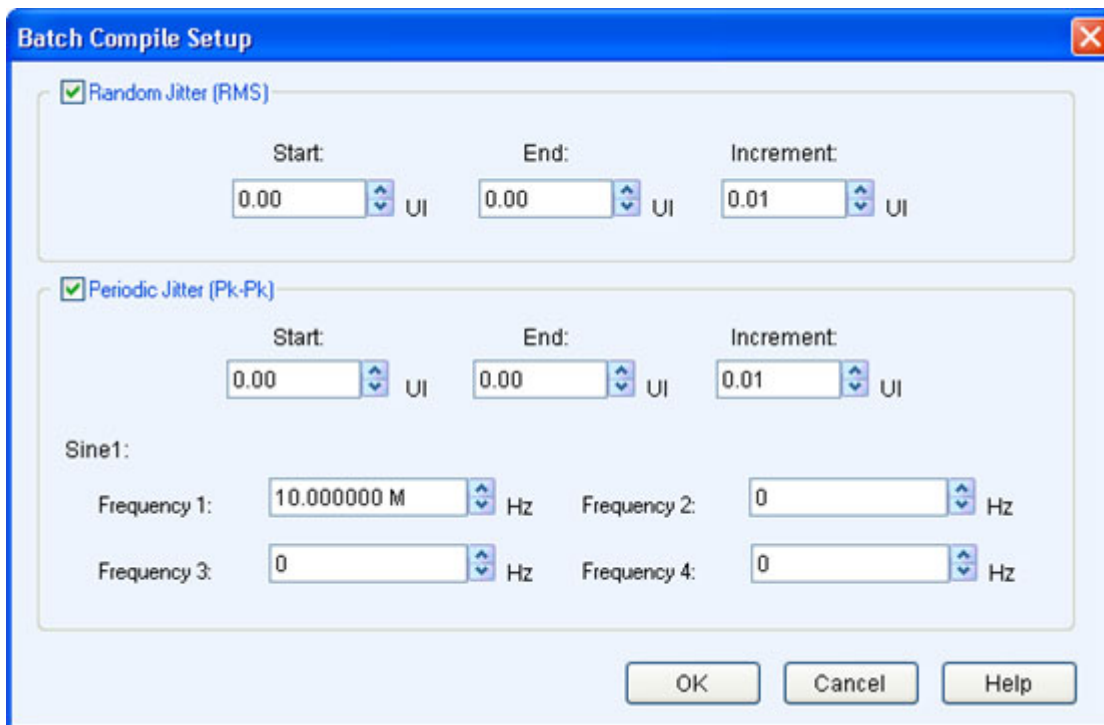

By default, both **Random Jitter** and **Periodic Jitter** are enabled where you can set the values to be used for batch creation. When you disable both the options and click **Compile**, the following error message appears: The parameter values do not generate any waveform.

The following condition occurs when Random Jitter (Rj) and/or Periodic Jitter (Pj) values are same in both the **Batch Setup Compile** dialog box and **Transmitter** tab:

- When either Rj or Pj is disabled in the **Batch Setup Compile** dialog box but enabled in the **Transmitter** tab, the corresponding value set in the **Transmitter** tab is used for compilation.
- When either Rj or Pj is disabled in both **Batch Setup Compile** dialog box and **Transmitter** tab, the value zero is used for compilation.

The following condition occurs when Random and/or Periodic Jitter have different values set in the **Batch Setup Compile** dialog box and **Transmitter** tab:

- When **Batch Process** is enabled in the **Compile Settings** dialog box, the values set in the **Batch Setup Compile** dialog box are used for compilation.
- When **Batch Process** is disabled in the **Compile Settings** dialog box, the value set in the **Transmitter** tab is used for compilation.

---

**NOTE.** The **Batch Process** option is available only for a single file. It cannot be applied when multiple pattern files or HDMI standard is selected.

---

**Table 10: Batch Compile Setup options and their description**

Selection	Description	Range, Default value
<b>Random Jitter (RMS)</b>		
Start	Set the random jitter start value (in UI).	0 UI to 0.5 UI, 0 UI
End	Set the random jitter end value (in UI).	0 UI to 0.5 UI, 0 UI
Increment	Set the random jitter increment value (in UI).	0 UI to 0.5 UI, 0.01 UI
<b>Periodic Jitter (Pk-Pk)</b>		
Start	Set the periodic jitter start value (in UI).	0 UI to 50 UI, 0 UI
End	Set the periodic jitter end value (in UI).	0 UI to 50 UI, 0 UI
Increment	Set the periodic jitter increment value (in UI).	0 UI to 0.5 UI, 0.01 UI
<b>Sine 1</b>		
Frequency 1	Set the first periodic jitter frequency (in Hz).	10 kHz to Data rate/2, 10 MHz
Frequency 2	Set the second periodic jitter frequency (in Hz).	10 kHz to Data rate/2, 0 Hz
Frequency 3	Set the third periodic jitter frequency (in Hz).	10 kHz to Data rate/2, 0 Hz
Frequency 4	Set the fourth periodic jitter frequency (in Hz).	10 kHz to Data rate/2, 0 Hz

---

**NOTE.** When the same frequency value is used more than once in the **Periodic Jitter**, only one frequency is used for compilation. If the value zero is set, that frequency is not used for compilation. Only **Sine1 Frequency 1** is used for compilation.

---

Click **OK** to save the changes and **Compile** to compile the waveform. The waveform name format is “Rj<value>Pj<value>Freq<value>”.

For Example: Rj0.2Pj0.1100000 means Rj of 0.2 UI, Pj of 0.1 UI applied on a frequency of 10 kHz.

## On/Off

Click **On/Off**  to turn on or turn off the AWG channel output. This option is enabled when SerialXpress is running in the online mode.

## Run

Click **Run**  to turn on or turn off the Run state of the AWG. If the application is running on an AWG or using an offline mode of the AWG software, then the compiled waveform is directly output to the channel and indicated by changing the Run button to green. This option is enabled when SerialXpress is running in the online mode.

## Option Installation

Click **System > Option Installation...** to use the SerialXpress application to generate, transfer, and save the waveforms. Once the [trial \(see page 1\)](#) expires, you cannot transfer or save the waveform unless you enable the function with an option (license) key.

Click **System > Option Installation...** This dialog box is displayed.

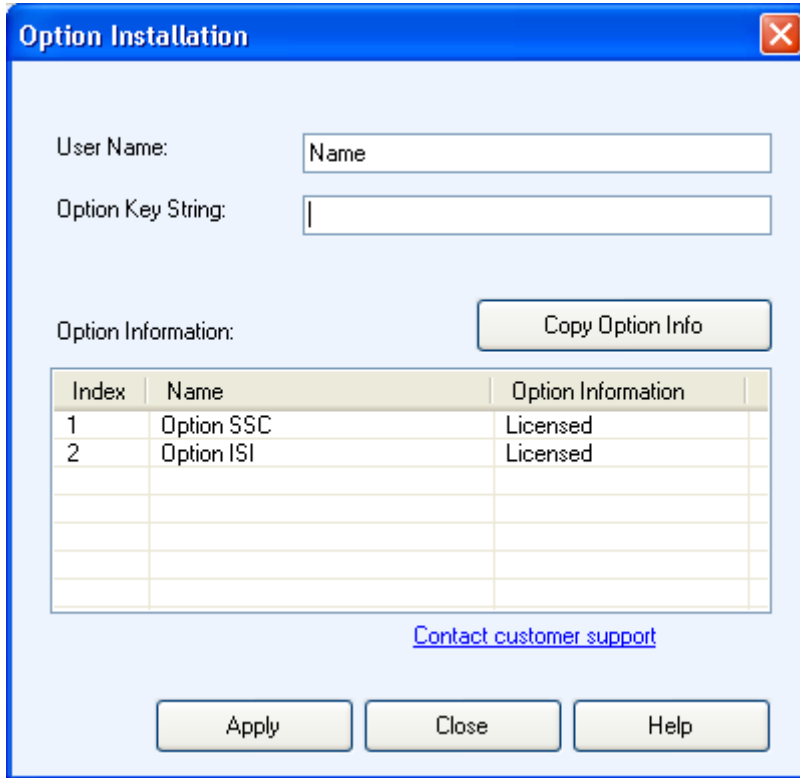

**Table 11: Option installation information and their description**

Selection	Description
User Name	Enter the user name.
Option Key String	Enter the 20 digit option key string that is provided along with the application.
Option Information	The option information is displayed in the table.

Click **Copy Option Info** to copy the information in the table to the clipboard. Click **Apply** to apply the entered values.

## Restore Default Setup

Click **File > Restore Default Setup** to restore the default values of all the parameters. This option is always enabled.

Clicking **Save** stores the current settings into a folder in sxs format and restores the default settings.



## Open Setup

Click **File > Open Setup...** to browse to open a saved setup file.

All files have the file name extension `sxs`. This option is always enabled.

## Save Setup

Click **File > Save Setup** to save the setup file in the `sxs` format.

Use **File > Save Setup** to save an existing setup file with the same name. If you are saving the setup for the first time, the **Save Setup** option works exactly as the **Save Setup As...** option. This option is always enabled.

## Save Setup As

Click **File > Save Setup As...** to save the data file in `sxs` format.

You must compile a setup before you can save the data. If you try to save a setup without compiling, you are prompted to compile the setup. This option is always enabled.

## Import from File

Click **File > Import from File...** to import a pattern file created in another application, and add these patterns into SerialXpress. This option is always enabled.

You can import only DTG files.

## Import from Tektronix Oscilloscope

Click **File > Import from Tektronix Oscilloscope...** to import a waveform file from a Tektronix oscilloscope that is connected to your AWG into SerialXpress. This dialog box is displayed. This option is always enabled.

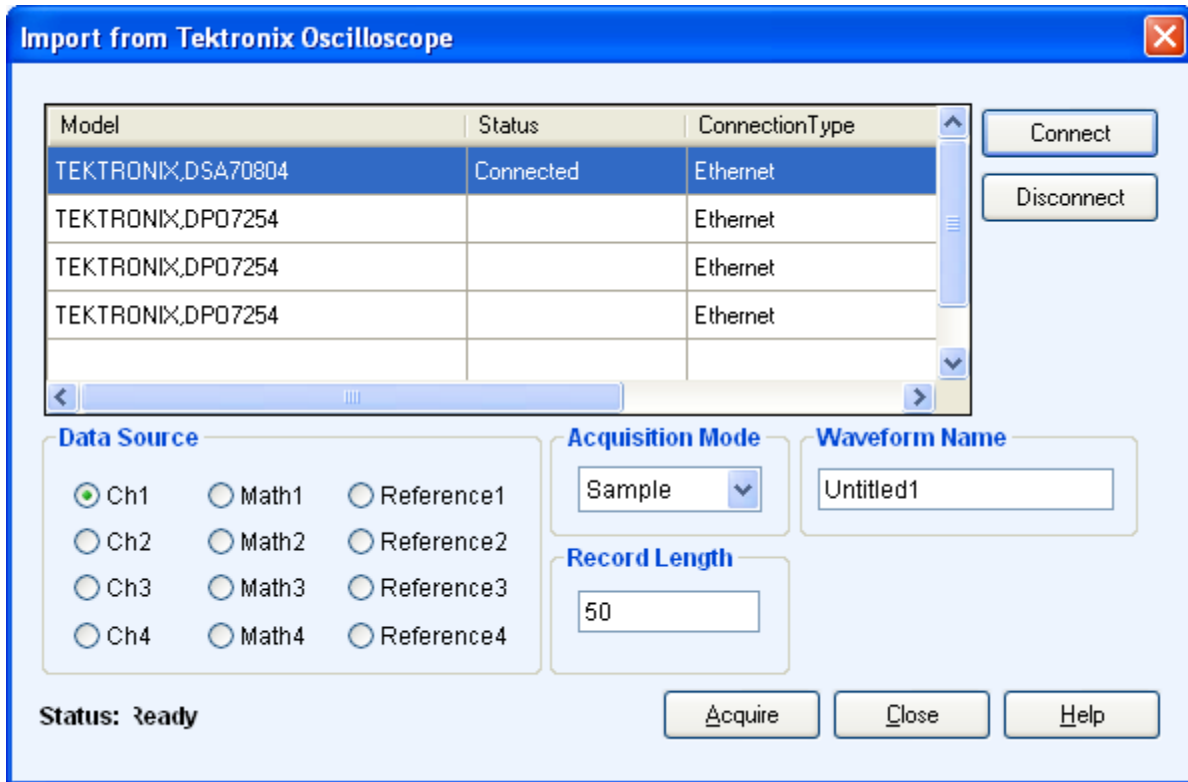

A table displays a list of oscilloscopes on the network. Select an oscilloscope in the table and click **Connect** to connect to it. You can connect more than one oscilloscope but can calibrate only one at a time. Click **Disconnect** to disconnect from an oscilloscope.

For a connected oscilloscope, you can set the following parameters:

**Table 12: Waveform import options and their description**

Selection	Description	Default value
Data Source	Select the data from which to acquire the waveform data: Ch1 to Ch4, Math1 to Math4, and Reference1 to Reference4.	Ch1
Acquisition Mode	Set the acquisition mode to one of the following: Samples, Peak Detect, Envelope, or Average.	Samples
Waveform Name	Specify the waveform name. The imported waveform is saved in the specified name.	N/A
Record Length	Displays the record length of the selected oscilloscope. Change the record length by entering a new value in the field.	N/A

Click **Acquire** to import the data. The specified waveform name is used to list the waveform in the Waveform List.

## PRBS Editor

This dialog box is displayed upon clicking **PRBS Editor...** when **Standard** is set to **General**, and **Pattern** to **User-Defined** in the **Base Pattern** tab.

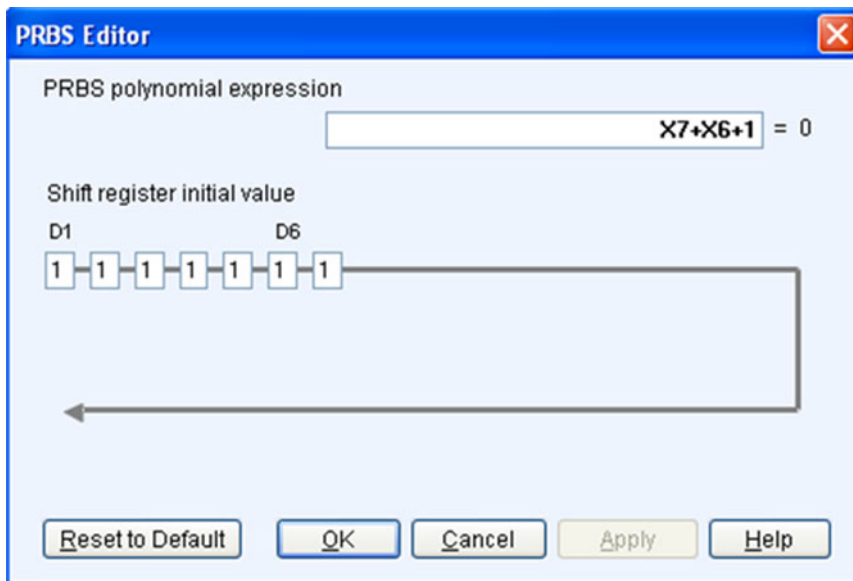

This data source can generate different pseudo-random binary sequences. The available PRBS patterns are: PRBS 7, PRBS 9, PRBS 15, and PRBS 16.

PRBS sequences are generated by a feedback shift register. The accepted value of the shift register text boxes is 1 or 0. The number (#) following PRBS indicates the length of the generating shift register. For instance, a shift register with 16 memory cells is required to generate a PRBS 16 sequence. The pseudo-random sequence of a PRBS generator is determined by the number of registers and the feedback.

**Table 13: PRBS editor options and their description**

Selection	Description	Default value
PRBS polynomial expression	Enter an expression in the format $Xn1+Xn2+1$ to generate the pseudo-random sequence. The value of $Xn$ ranges between 1 and 31.	$X7+X6+1$
Shift register initial value D1– D31	Enter values in the shift registers to create the sequence. The registers D1 through D31 can take the values 0 and 1.	D1– D31

---

**NOTE.** *SerialXpress does not support patterns of all zeroes when the user-defined PRBS equation is selected.*

---

Click **Apply** to effect the changes. Click **Reset to Default** to restore the editor to the default values.

For more details, refer to [PRBS Editor Starting Values \(see page 70\)](#).

## Setting the Base Pattern

Base data is always in the form of zeroes and ones. Base data can be of two types:

- Standard patterns (such as SATA, HDMI patterns) provided as part of the SerialXpress application
- User created patterns

When you select User Defined patterns, you might need to encode them. SerialXpress supports common encoding techniques such as 8B10B, NRZ, and NRZI.

NRZI (no-return to zero inverted), where “0” indicates no change and “1” indicates the current level. If the current waveform is high, a “1” bit value causes a transition to the low waveform level. If the current waveform level is low, a “1” bit value causes a transition to the high waveform level. Refer to the following example.

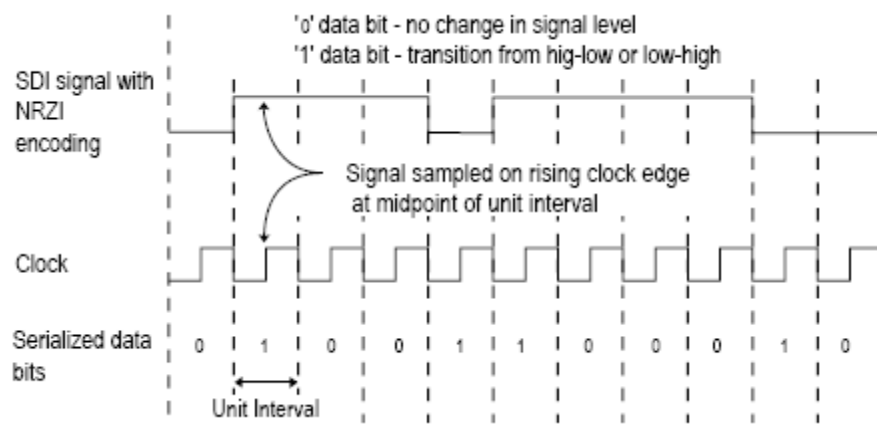

This is used to encode an 8-bit data to a 10-bit data. This is the most common encoding mechanism used for Serial data standards. For example SATA patterns are 8B10B encoded.

NRZ (no-return to zero), where “0” indicates low value and “1” indicates high value.

Encoding is a process by which input patterns (zeroes and ones) are modified to different patterns (again zeroes and ones in various combinations).

To define the base pattern and source, waveform characteristics, encoding scheme, and rise/fall time parameters, do the following:

1. Set the base pattern. This can be done in either of the following two methods:

### Method 1: Selecting the Standard Base Pattern

- Select the standard from the list: SATA, SAS, HDMI, Display Port, PCI-Express, Fiber Channel, General, and USB.
- Select the pattern from a file. The available options depend on the selected standard as follows:

---

**NOTE.** The **General** standard and **Clock** pattern are the default settings.

---

**Table 14: Standard and Pattern options**

Option	Pattern selections	Default
SATA	The selections for SATA are: MFTP, HFTP, SFCP4AlignR12, and others.	MFTP
SAS	The selections for SAS are: JTPAT_RD+ , JTPAT_RD-, and others.	JTPAT_RD+
HDMI	The selections for HDMI are: 480p 8 59 Gray RGB, 720p 8 60 Gray RGB, and others.	480p 8 59 Gray RGB
DisplayPort	The selections for DisplayPort are: DP Training sequence2 960, PRBS7, and others.	PRBS7
PCI-Express	The selection for PCI-Express is: Compliance Pat.	Compliance Pat
Fiber Channel	The selection for Fiber Channel are: CJTPAT, JTPAT, and others.	CJTPAT
General	The selections for General are: Clock, PRBS7, PRBS9, and others.	Clock This pattern has a high frequency clock, such as 1,0,1,0,1,0,...
USB	The selections for USB are: MinAdd1N and MinAdd1P	MinAdd1N

## Method 2: Selecting the From File Base Pattern

Browse to select a file from which to take the pattern. The file format is `txt`.

SerialXpress supports:

- Selecting a single pattern file from mass storage. See [Creating the Base Data \(see page 40\)](#).
- Selecting multiple pattern files from mass storage. See [Creating the Base Data \(see page 40\)](#).

---

**NOTE.** *Selecting single or multiple pattern files allows you to encode the selected data. You can skip the encoding if not required.*

*When multiple pattern files are selected, the encoding type applies to all the selected pattern files.*

---

- Selecting from a list of pattern data supplied with the application.

**Method 3: Selecting a User Pattern**

- Select any of the User Pattern formats: Binary, Hex, or Symbol. By default, Binary is selected.
- Enter the pattern in the text box.

You can enter up to 20 zeroes and ones. If you want to enter more than 20 digits, click **Editor...** In the **User Pattern Editor** dialog box, you can enter up to 128 digits for Hex mode, 512 digits for Binary mode, 64 symbols for Symbol mode.

---

**NOTE.** *Patterns with all zeroes or all ones are not supported.*

---

The format for Symbol mode is Dxx.y or Kxx.y. The first character is either D or K.

You can enter up to four symbols, each separated by a comma.

For the D character, the value of x is in the range 0 to 31 and y is in the range 0 to 7.

For the K character, the value of x and y are as follows:

K28.0 = 100011100

K28.1 = 100111100

K28.2 = 101011100

K28.3 = 101111100

K28.4 = 110011100

K28.5 = 110111100

K28.6 = 111011100

K28.7 = 111111100

K23.7 = 111110111

K27.7 = 111111011

K29.7 = 111111101

K30.7 = 111111110

2. Set the following signal characteristics:

**Table 15: Signal characteristics and their description**

Option	Description	Range, Default value
Data Rate	Specify the data rate (in b/s) of the waveform.	Range: 500 Kb/s to 6 Gb/s (AWG7000B without interleave) 500 Kb/s to 12.0 Gb/s (AWG7000B with interleave) 500 Kb/s to 3300 Mbps (AWG5000) 500 Kb/s to 12 Gb/s (Offline) Default: 1 Gb/s
Idle State	Enter the idle state value (in samples or secs) of the waveform.  Idle state is the state used for some standards like SATA. During this state, the value is neither 0 nor 1. It is a state during which no valid data is transferred between the transmitter and the receiver. SerialXpress supports Idle state waveforms with idle value.  Idle state waveforms are individual waveforms that can be sent to the AWG. Use sequence mode to take the receiver to the idle state. The waveforms contain the DC values with no base data during this state. You can add number of samples and noise as required in the idle state waveform.	53 ns to 100 $\mu$ s, 320 ns

The default data rate changes depending on the selected standard. You can change the data rate if necessary. The following table lists the default data rate for various standards.

**Table 16: Signal standards and their default data rates**

Signal standards	Data rate
SATA	3 Gb/s
SAS	3 Gb/s
HDMI	3.2 Gb/s
DisplayPort	2.7 Gb/s
PCI-Express	5 Gb/s
Fiber Channel	4.25 Gb/s
USB	480 Mb/s



---

**NOTE.** When you select **Idle State**, all the parameters in the **Encoding**, **Amplitude**, and **Rise/Fall** groups are disabled.

---

SerialXpress can generate waveforms that occupy only a part of the full DAC range of the AWG. By default, the generated waveforms occupy the whole DAC range. When SerialXpress is in the online mode, the maximum voltage corresponds to the full DAC of the AWG on which it is running. When SerialXpress is in the offline mode, the maximum range is assumed to be 1 Vpp (peak-to-peak).

3. Set the following amplitude parameters:

**Table 17: Amplitude options and their description**

Option	Description	Default
Maximum	Specify the maximum amplitude (in volts) of the waveform.	+0.5 V to –0.25 V Default: +0.5 V (Offline) Depends on the maximum amplitude value of the AWG (Online)
Minimum	Specify the minimum amplitude (in volts) of the waveform.	+0.25 V to –0.5 V Default: –0.5 V (Offline) Depends on the maximum amplitude value of the AWG (Online)

4. Select the following encoding scheme:

**Table 18: Encoding options and their description**

Option	Description	Default
Scheme	Select the encoding scheme to use: NONE (NRZ) or NRZI.	None
8B10B	Select 8B10B to encode an 8-bit data to 10-bit data.	Disabled
Disparity	Select the disparity: Positive or Negative.	RD+
Disparity refers to starting disparity.	<b>NOTE.</b> This option is enabled only if 8B10B is enabled.	

- SerialXpress allows both equal and unequal rise and fall times. Set the following rise/fall time parameters:

**Table 19: Rise/Fall Time options and their description**

Option	Description	Range, Default value
Rise/Fall Time	Set the Rise/Fall time option to 10/90 or 20/80. This defines whether rise and fall times are calculated using 10/90 or 20/80 ratio.	10/90 or 20/80, 10/90
Rise	Set the rise time in s or UI. The rise time is used to define how steep the rising slope will be.	Range: 0.6/sampling rate to 0.6/data rate Default: 100 ps
DCD	Set the DCD in s or in UI.  When DCD is disabled, the rise and fall times can be controlled. When DCD is enabled, the rise and fall times are calculated separately to achieve the required DCD.	0 UI to 1 UI, 0 UI
Fall	Set the fall time in s or UI.  When fall time is enabled, DCD is calculated internally. When DCD is enabled, the fall time value is calculated internally.	Range: 0.6/sampling rate to 0.6/data rate Default: 100 ps

When you change the unit for rise and fall times from UI to secs, or secs to UI, the value of rise and fall time changes to reflect their equivalent in the new unit.

A unit interval (UI), also referred to as a bit time, is the time taken in a data stream for one bit. For example, in a serial line with a baud rate of 2.5 Gb/s, a unit interval is  $1/(2.5 \text{ Gb/s}) = 0.4 \text{ ns/bit}$ .

## Creating the Base Data

### Selecting single or multiple pattern files from mass storage

The pattern format for single or multiple pattern files is as shown:

---

**NOTE.** *The file format is `txt`. If a pattern file does not have the specified data in any row or data bit as follows, then the waveform generation fails.*

---

Row<1> D1 D2 D3 D4 D5 D6 D7 D8 D9 D10<CR><LF>

Row<2> D11 D12 D13 D14 D15 D16 D17 D18 D19 D20<CR><LF>

Row<3> D21 D22 D23 D24 D25 D26 D27 D28 D29 D30<CR><LF>

.....<CR><LF>  
 Row<n>.....<CR><LF><EOF>

where,

Row<n> refers to row number.

D30 to D1 refers to data bits with the values 1 or 0.

<CR> refers to carriage return.

<LF> refers to line feed.

<EOF> refers to end of file.

---

**NOTE.** Row number and EOF do not appear as part of the file.

---

<CR> and <LF> together can be considered as the end of line.

Selecting single or multiple pattern files allows you to encode the selected data. You can skip the encoding if not required.

---

**NOTE.** When multiple pattern files are selected, the encoding type applies to all the selected pattern files.

---

**File format for 8-bit data.**

<D1>,<D2>,<D3>,<D4>,<D5>,<D6>,<D7>,<D8>,<M1>,<M2><CR><LF>  
 <D11>,<D12>,<D13>,<D14>,<D15>,<D16>,<D17>,<D18>,<M1><M2><CR><LF>

where, <M1>,<M2> are the marker bits.

The file format for 8-bit data is as follows:

```

0, 0, 0, 0, 0, 0, 0, 0, 0, 1, 1
0, 0, 0, 1, 1, 1, 0, 0, 0, 0
0, 0, 1, 1, 1, 0, 0, 0, 0, 0
0, 1, 0, 1, 0, 1, 0, 1, 0, 0
0, 1, 1, 1, 0, 0, 0, 1, 0, 0
1, 0, 0, 0, 1, 1, 0, 1, 0, 0
1, 0, 1, 0, 1, 0, 0, 1, 0, 0
1, 1, 0, 0, 0, 1, 1, 0, 0, 0
1, 1, 1, 0, 0, 0, 1, 0, 0, 0
1, 1, 1, 1, 1, 1, 1, 0, 0, 0
    
```

**File format for 10-bit data.**

<D1>,<D2>,<D3>,<D4>,<D5>,<D6>,<D7>,<D8>,<D9>,<D10><CR><LF>

<D11>,<D12>,<D13>,<D14>,<D15>,<D16>,<D17>,<D18>,<D19>,<D20><CR><LF>

The file format for 10-bit data is as follows:

```

0,0,0,0,0,0,0,0,0,0,0
0,0,0,1,1,1,0,0,1,0
0,0,1,1,1,0,0,0,1,1
0,1,0,1,0,1,0,1,0,1
0,1,1,1,0,0,0,1,1,0
1,0,0,0,1,1,1,0,0,0
1,0,1,0,1,0,1,0,0,1
1,1,0,0,0,1,1,0,1,1
1,1,1,0,0,0,1,1,0,0
1,1,1,1,1,1,1,1,1,0

```

**File format for symbol data.**

<Symbol><CR><LF>

<Symbol><CR><LF>

<Symbol><CR><LF>

<Symbol><CR><LF>

<Symbol><CR><LF>

---

**NOTE.** By default, all the symbols are assumed to be 8-bit non-encoded data. Use encoding to encode symbol data. By default, the NRZ encoding scheme is selected. You can select more than one encoding scheme from the available options. When 8B10B encoding is selected along with the other encoding, the 8B10B encoding will be applied at the end.

When any encoding other than 8B10B encoding is applied to a pattern file containing D and K characters, the application cannot distinguish between these characters. In such cases, all the characters are assumed to be D.

---

The following format is selected as input to the SerialXpress, when both NRZI and 8B10B encoding are selected:

D28.5

D16.3

D13.3

K28.5

The output file format is as follows:

D28.5

D16.3

D13.3

D28.5

The final output will have all D characters.

If only the 8B10B encoding is selected, the application generates the output for K28.5.

## Calibration for Base Pattern Signals

Calibration is available only when the SerialXpress is running on an AWG series instrument.

For Base Pattern waveforms, connect the AWG and oscilloscope as follows:

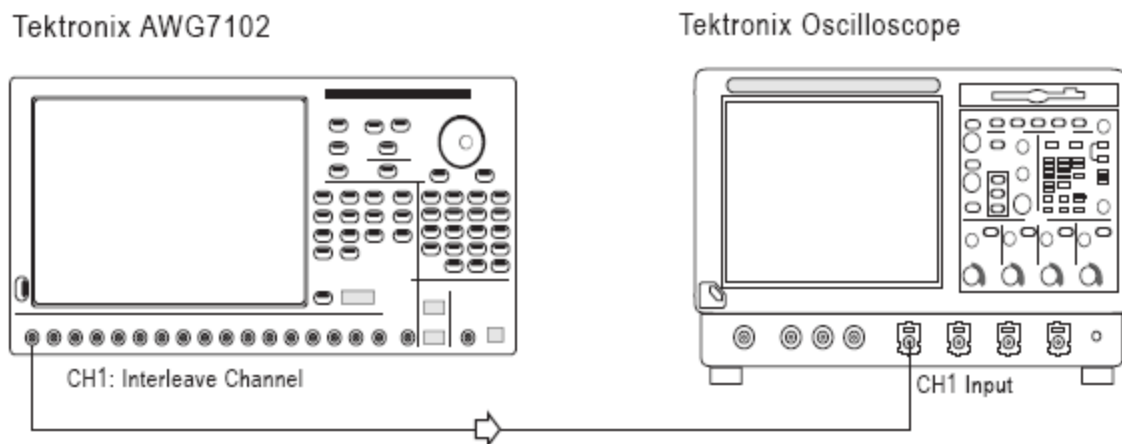

The rear panel connections of the AWG and oscilloscope are as shown:

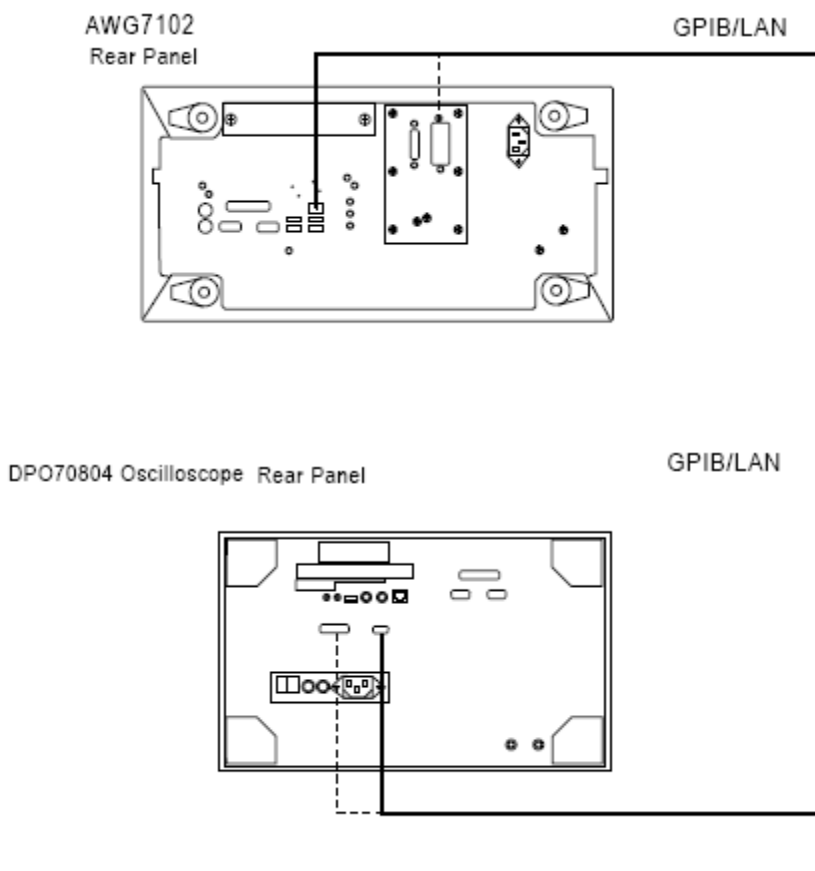

### Creating Calibration Data

1. Select **Calibration** from the toolbar.
2. From the list of instruments, highlight an oscilloscope and click **Connect**.
3. Set the Calibration parameters. The calibration parameters are: Sampling rate, Data rate, Interleave, and Zeroing. You can leave these parameters with their default values or set them as you like. For more details, refer to [Calibration \(see page 18\)](#).
4. Click **Calibrate**. A status message displays the status of processing.

---

**NOTE.** The difference between the generated waveform and the reference waveform is calculated for each iteration.

---

The files (.sxc) created contains calibration data.

## Setting Jitter Parameters

Click **Transmitter** tab to add periodic and random jitter to the waveform that you want to create. To add jitter, do the following:

1. To introduce one or more sine waves as periodic jitter, enable one or more check boxes. Set the Magnitude (UI), Frequency (Hz), and Phase (°) for each.

**Table 20: Setting periodic jitter parameters**

Option	Description	Range, Default
Magnitude	Set the magnitude of the sine wave (jitter) (in UI) to introduce.	0 UI to 50 UI, 0 UI
Frequency	Set the frequency of the sine wave (jitter) (in Hz) to introduce.	10 kHz to Data rate/2, 10 MHz
Phase	Set the phase of the sine wave (jitter) (in degrees) to introduce.	0 ° to 360 °, 0 °

For examples on periodic jitter, refer to [Periodic Jitter Sample Test Results \(see page 77\)](#).

2. To add one or more random jitters, enable one or more check boxes. Set the Magnitude (UI), Frequency-Low (Hz), and Frequency-High (Hz) for each.

**Table 21: Setting random jitter parameters**

Option	Description	Range, Default
Random Seed	Set this option to use the same random jitter sequence during each compilation. The required random jitter sequence is generated through a 5-digit seed. By keeping the 5-digit seed constant, the same random jitter sequence is generated during each compilation.  When disabled, the uncorrelated random jitter sequence is generated during each compilation.	1 to 99999, 12345
Magnitude	Set the magnitude of the sine wave (jitter) (in UI) to introduce.	0 UI to 0.5 UI, 0 UI
Frequency-Low	Set the low frequency of the sine wave (jitter) (in Hz) to introduce.	1 Hz to (Frequency-High – 1 M), 100 kHz
Frequency-High	Set the high frequency of the sine wave (jitter) (in degree) to introduce.	1.1 MHz to Data rate/2, Data rate/2

The random jitter generated through a random sequence is independent for each compilation.

3. To specify SSC parameters, select **SSC** and set the following parameters:

Table 22: Setting SSC parameters

Option	Description	Range, Default value
Shape	Select the shape of the SSC profile to use. The available selections are: Sine, Triangle, and <a href="#">Custom (see page 74)</a> .	Triangle
Spread	Select the SSC spread to use. The available selections are: Up, Down, Center, and Unequal.	Down
Unequal Spread	Enter the unequal spread.	0% to 100%, except 50 indicates unequal spread. 0 is equivalent to <b>Down</b> spread. 50 is equivalent to <b>Center</b> (equal) spread. 100 is equivalent to <b>Up</b> spread. Default: 0%
<b>df/dt</b>		
Minimum Duration	Enter the minimum duration of df/dt. The duration is the same for both the rising and falling edges.	0 $\mu$ s to 5 $\mu$ s, 0 $\mu$ s
Location	Enter the location of df/dt. This specifies the location (in % of height) of the df/dt spike on both the edges. The spikes are located symmetrically on both the rising and falling edges.	20 % to 80 %, 50 %
df/dt	Enter the df/dt of the waveform. This defines the sudden deviation (spikes) of the SSC profile from the predefined pattern. The number of spikes per cycle is 10.	0 ppm/ $\mu$ s to 5000 ppm/ $\mu$ s, 0 ppm/ $\mu$ s
<b>Frequency</b>		
Deviation (Hz)	Enter the frequency deviation. This defines the maximum deviation of the data rate from mean data.	0 ppm to 200000 ppm, 4000 ppm
Modulation	Enter the frequency modulation. This defines the frequency of the modulating SSC profile.	10 kHz to 500 kHz, 33 kHz



4. SerialXpress supports adding noise and peak controlled pre-emphasis. Select and enter the following:

**Table 23: Noise and Pre-Emphasis options and their description**

<b>Option</b>	<b>Description</b>	<b>Range, Default</b>
Noise	Enter the amplitude of the noise (in volts) to generate.	0 Volt (RMS) to 0.5 Volt (RMS), 0 Volt (RMS)
Pre/De-emphasis	Enter the amplitude (in dB or volts) of the pre-emphasis to be introduced in the waveform.	0 dB to 20 dB, 0 dB
Add Noise At	Select where the random noise will be added to the waveform. It can be added to simulate the near end or far end.	Near end and Far end, Near end

## Setting ISI and S-Parameter Filter Parameters

Click **Channel/Cable** tab to specify inter-symbol interference (ISI) or S-Parameter Filter parameters for the waveform.

1. To specify the ISI, select the **ISI** option.
2. To specify the S-Parameter filter, select the **S-Parameter Filter** option.
3. Set the following channel/cable parameters:

**Table 24: Channel/Cable options and their description**

Option	Description	Range, Default
ISI	Select this option and specify the inter-symbol interference (in UI or seconds).	0 UI to 1 UI, 0 UI
<b>S-Parameter Filter</b>		
Read from File	Browse and select the file from which to read the filter. The files supported are s1p, s2p, and s4p.	s4p
Inverse Filter	Select this to apply an inverse filter. This is used to neutralize the effect of the cable and produce an undistorted waveform. To get an undistorted waveform, select the corresponding S-Parameter file of the cable in use using the <b>Read from File</b> . Inverse Filter is applied to the generated waveform and passed through the cable to the DUT. An undistorted Eye DPO waveform is produced at the DUT.	Disabled
<a href="#">ISI Scaling (see page 74)</a>	Enter the ISI scaling.	0 to 10, 1

The S-parameter (Touchstone) file can contain data for 1-port, 2-port, or 4-port devices. Once a file is selected, the application reads its contents and generates the appropriate dialog box for you to select the particular S-parameter in the file to use.

- **One-port:** Files with one port of data contain only one S-parameter file (s1p) so they do not require any further input.
- **Two-port:** Files with data for two ports contain four S-parameters as a 2x2 matrix. These are Touchstone 2-port files (s2p). When the application recognizes such an S-parameter file, a dialog box is created for you to select the S-parameter representing channel transmission. By default, SerialXpress assumes the location of the channel transmission data in the file to be S<sub>21</sub>.

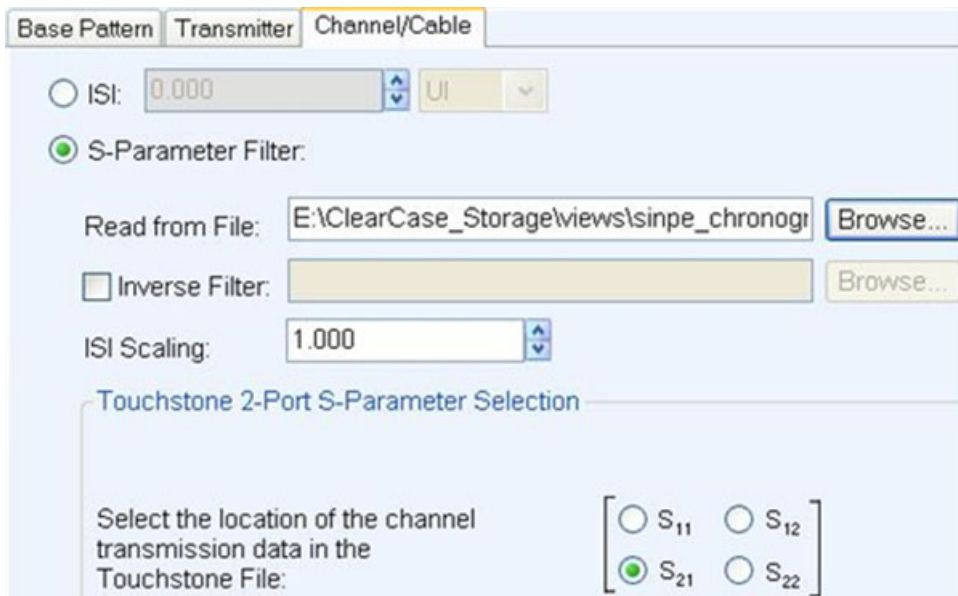

- Four-Port:** Files with data for four ports may contain single-ended or differential data. These are Touchstone 4-port files (s4p). By default, SerialXpress assumes the file to be Differential data type. If the data is single-ended, you must map the port numbers as used in the file to physical locations in your link. A default mapping is assumed. The application will use this mapping to compute the  $S_{dd21}$  parameter (for transmission of a differential signal) from the appropriate four S-parameters measured using single-ended data.

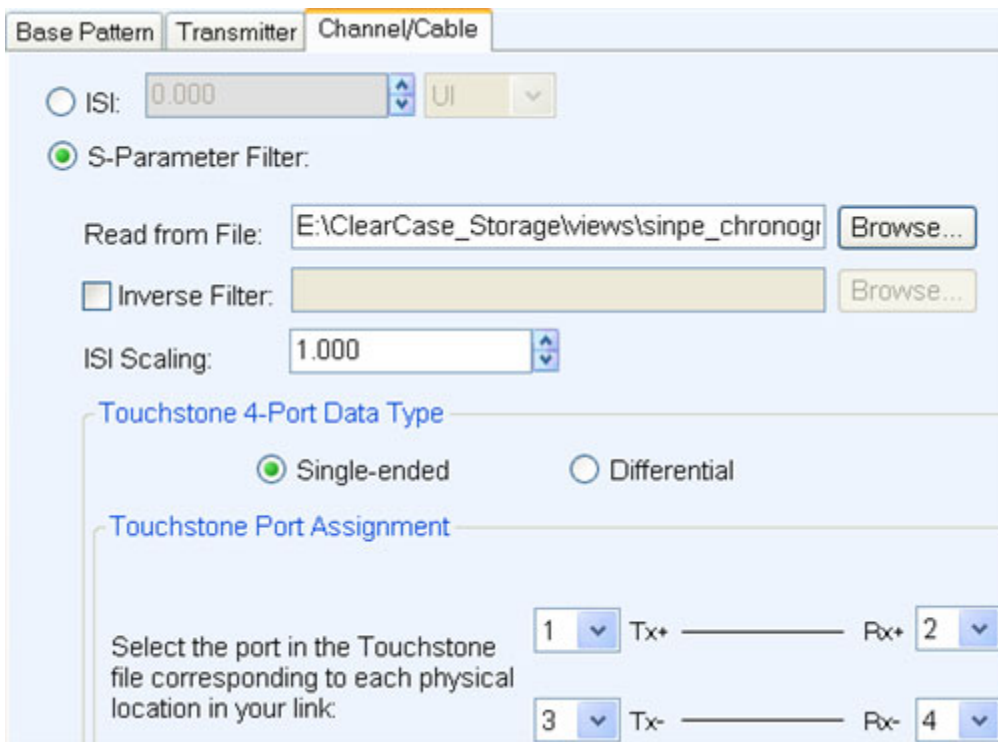

You can select the port for both transmitter and receiver from the drop-down list. Each drop-down list has ports from 1 to 4. The default port number is as follows:

Type	Default port
Tx+	1
Tx-	3
Rx+	2
Rx-	4

If the data is differential, you must select the data layout in the file. By default, SerialXpress assumes the file to use DC12 data location format. The application always uses the  $S_{dd21}$  parameter for computing the transmitted waveform no matter which mapping is selected.

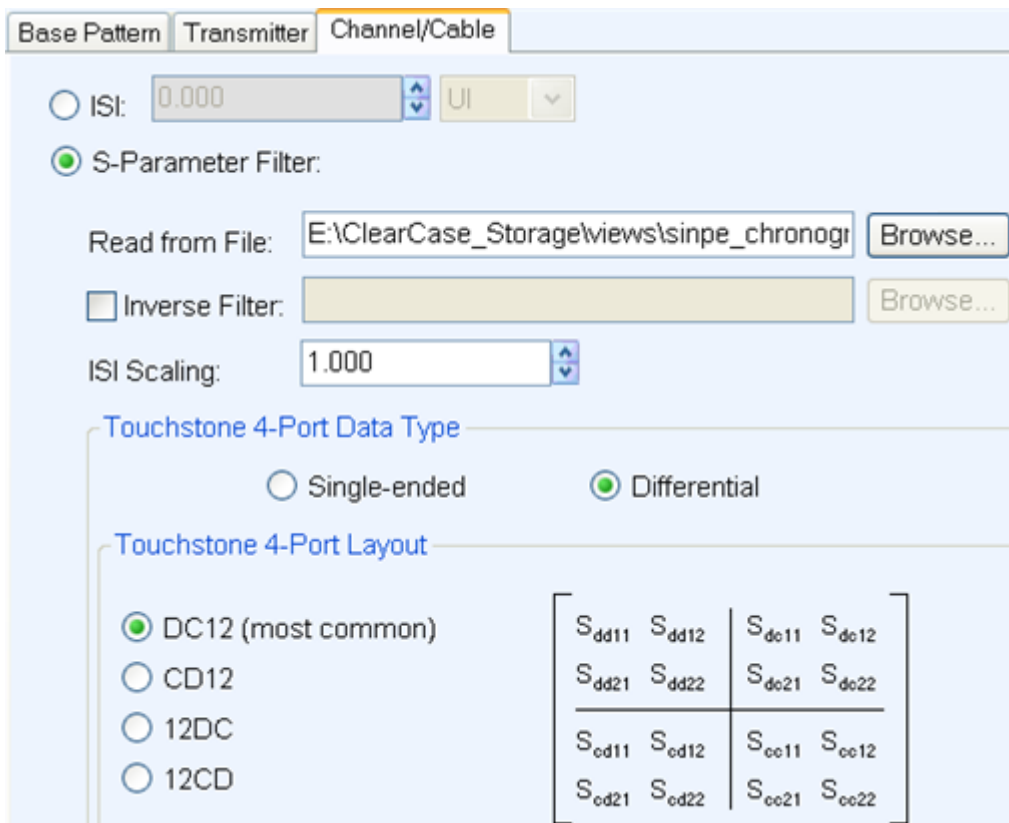

## AWG

SerialXpress interfaces with an AWG in the following ways:

- Installing SerialXpress on an AWG series instrument can directly send and receive data from the AWG.
- Installing an offline version of SerialXpress on a PC with an offline version of the AWG software can detect the presence of the AWG software and send data to it. This data can be opened and viewed in the AWG software.

You can control the following AWG parameters:

- Channel waveform
- Amplitude
- Sampling rate
- Interleave (AWG7102 Option 06 only)
- Interleave Zeroing (AWG7102 Option 06 only)

SerialXpress supports the following operations:

- Transferring a waveform data to AWG as real format waveform. During this operation, the marker data is also transferred.
- Loading a waveform to a channel.
- Changing the run state.

Do the following steps to control and transfer a waveform to an AWG:

1. Select **Window > Instrument Control**.
2. From the **AWG** tab, you can modify the values of the following AWG parameters:

**Table 25: AWG parameters and their description**

Selection	Description	Default value
Sampling Rate	Displays the sampling rate of the AWG.	The default is as set in the AWG.
<a href="#">Interleave (see page 70)</a>	Sets the interleave option to On or Off.	Off
<a href="#">Zeroing (see page 72)</a>	Enabled only when Interleave is set to On.	Disabled
Ch 1	Select this to receive the output from channel 1.	This depends on the channel present on the AWG.
Ch 2	Select this to receive the output from channel 2.	This depends on the channel present on the AWG.

**Table 25: AWG parameters and their description (cont.)**

<b>Selection</b>	<b>Description</b>	<b>Default value</b>
Amplitude (Vpp)	Displays the amplitude of the selected channel. Change the amplitude in this field to change the amplitude on the channel.	The default is as set in the AWG.
Waveform	Displays the selected waveform name. You can drag and drop the waveform from the Waveform List. When you drag and drop a waveform, the sampling rate is automatically set.	N/A

The following button is available:

**Table 26: AWG options**

<b>Button</b>	<b>Description</b>
Advanced	Opens a dialog box where you can set the advanced AWG control options.

3. When you click **Advanced**, the following options are available for each channel:

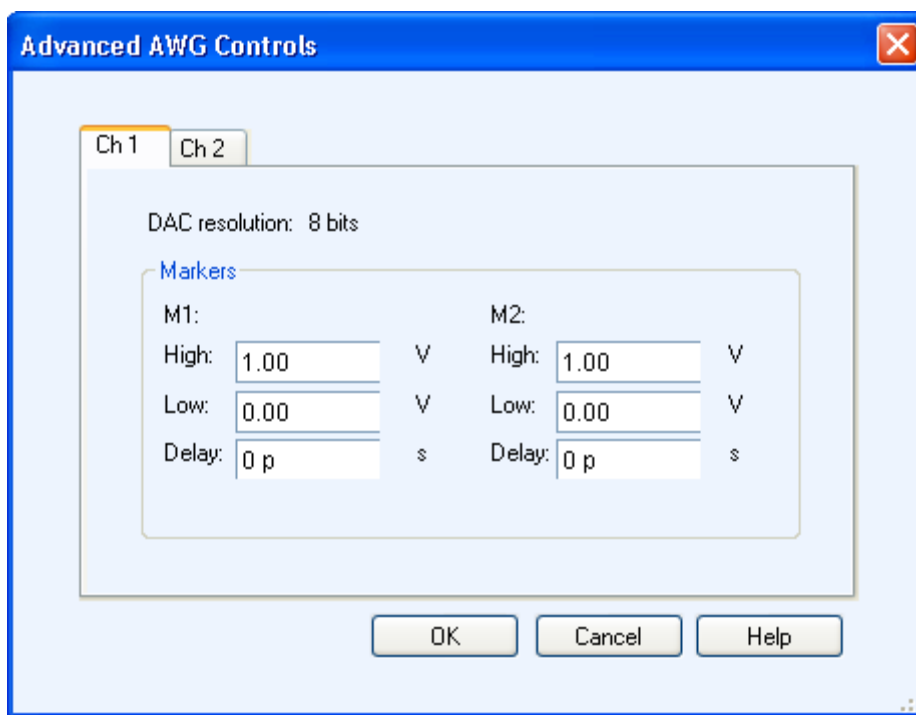

Table 27: Advanced AWG parameters

Selection	Description
<b>DAC Resolution</b>	
8 bits	Sets the DAC resolution to 8 bits.
10 bits	Sets the DAC resolution to 10 bits. When the DAC resolution is set to 10 bits, the marker options are not available.
<b>Markers (M1 and M2)</b>	
High (V)	Enter the high value for the markers.
Low (V)	Enter the low value for the markers.
Delay (s)	Enter the maker delay.

**NOTE.** When connected to an AWG5000/B series instruments, the DAC resolution is fixed to 14 bits and cannot be changed.

## Oscilloscope

SerialXpress can be used to control a connected Tektronix oscilloscope, acquire oscilloscope waveforms into SerialXpress, and transfer it to an AWG.

Follow these steps to find oscilloscopes connected to the AWG on which SerialXpress is running:

1. Select **Window > Instrument Control**.
2. A table lists the connected oscilloscopes. From the **Oscilloscope** tab, you can modify the values of the following oscilloscope parameters:

---

**NOTE.** *Ensure that the Sampling mode on the oscilloscope is set to Real Time. If the Sampling mode is set to Interpolation (either automatically or manually), the parameter values in SerialXpress Instrument control and the oscilloscope may not match.*

---

3. Click **Find Instruments**. The following dialog box opens.

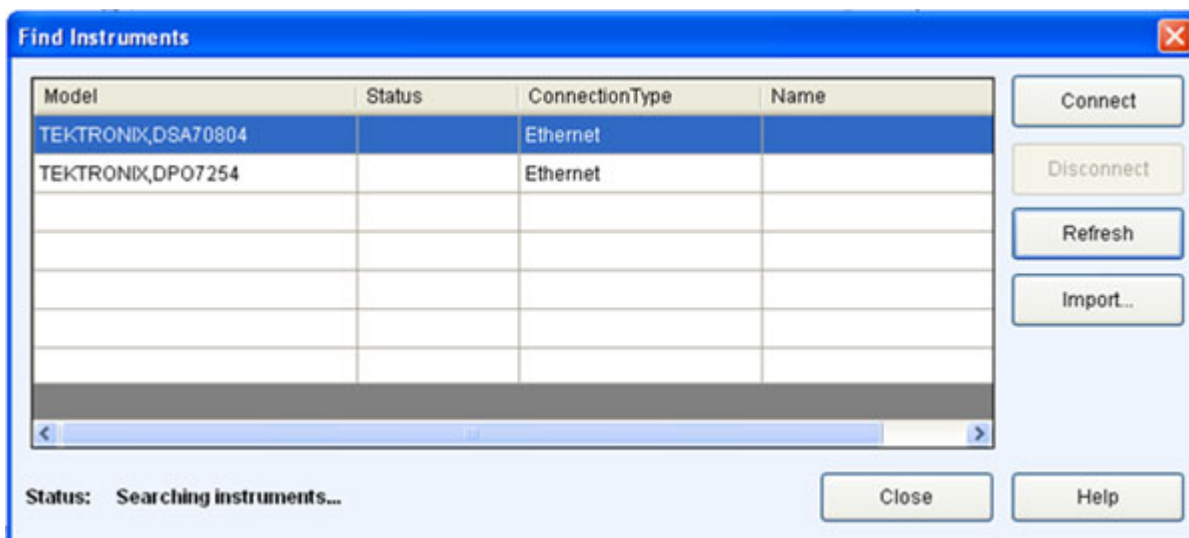

The table lists the oscilloscopes found along with the name of the model, status (connected or not), and the connection type (Ethernet or GPIB).



4. Select an oscilloscope from the table. Use the following buttons to:

**Table 28: Find instruments options and their description**

Button	Description
Connect	Allows you to connect to the selected oscilloscope in the table. Enabled by default if an oscilloscope is highlighted in the table; disabled if no oscilloscope is highlighted.
Disconnect	Allows you to disconnect the connected oscilloscope. Enabled only when an oscilloscope is connected.
Refresh	Refreshes the list of oscilloscopes.
<a href="#">Import... (see page 31)</a>	Opens the <b>Import from Tektronix Oscilloscope...</b> dialog box.

5. Click **Connect** to connect to the selected oscilloscope.

**Table 29: Oscilloscope parameters**

Selection	Description
<b>Vertical Settings</b>	
Channel	Displays the channel to which to output the waveform. To change this setting, select another channel.
Scale (V)	Displays the vertical scale set in the oscilloscope for the selected channel. Change the value in this field to change the vertical scale on the connected instrument.
<b>Horizontal Settings</b>	
Scale (s)	Displays the horizontal scale set in the oscilloscope. Change the value in this field to change the horizontal scale on the connected instrument.
Record Length	Displays the record length set in the oscilloscope. Change the value in this field to change the record length on the connected instrument.
Sampling Rate (S/s)	Displays the sampling rate set in the oscilloscope. Change the value in this field to change the sampling rate on the connected instrument.
<b>Acquisition</b>	
Run	Starts the acquisition of data on the oscilloscope.
Stop	Stops the acquisition of data on the oscilloscope.
Single	Sets the oscilloscope to acquire one full record length and then stops.

The following buttons are available in this tab:

**Table 30: Oscilloscope options**

<b>Button</b>	<b>Description</b>
AutoSet	Performs autoset on the oscilloscope.
Refresh Settings	Refreshes the display with the current instrument settings.
Refresh List	Refreshes the connection status of the instruments.
Find Instruments	Finds instruments on the network.

## Zooming Graphs

You can zoom in or zoom out on a graph. Click **Maximize** to display the graph in a large window. You can zoom in on a plot by selecting an area of interest. SerialXpress supports the following graphs:

- [Rise/Fall \(see page 58\)](#)
- [Simulated Data Signal \(see page 59\)](#)
- [Random Jitter \(see page 60\)](#)
- [Periodic Jitter \(see page 61\)](#)
- [Total Jitter \(see page 62\)](#)
- [Normal Eye \(see page 63\)](#)
- [Eye DPO \(see page 64\)](#)
- [TIE \(see page 65\)](#)

You cannot save the graphs. You can only save the graphs by doing a screen capture. You must regenerate a graph using **Compile** every time you change parameter values. The existing graphs are not automatically updated.

For more details, refer to [Graph Setup \(see page 21\)](#).

## Rise/Fall

The rise/fall graph shows the plot of Time (Samples) (X-axis) and Amplitude (Volts) (Y-axis).

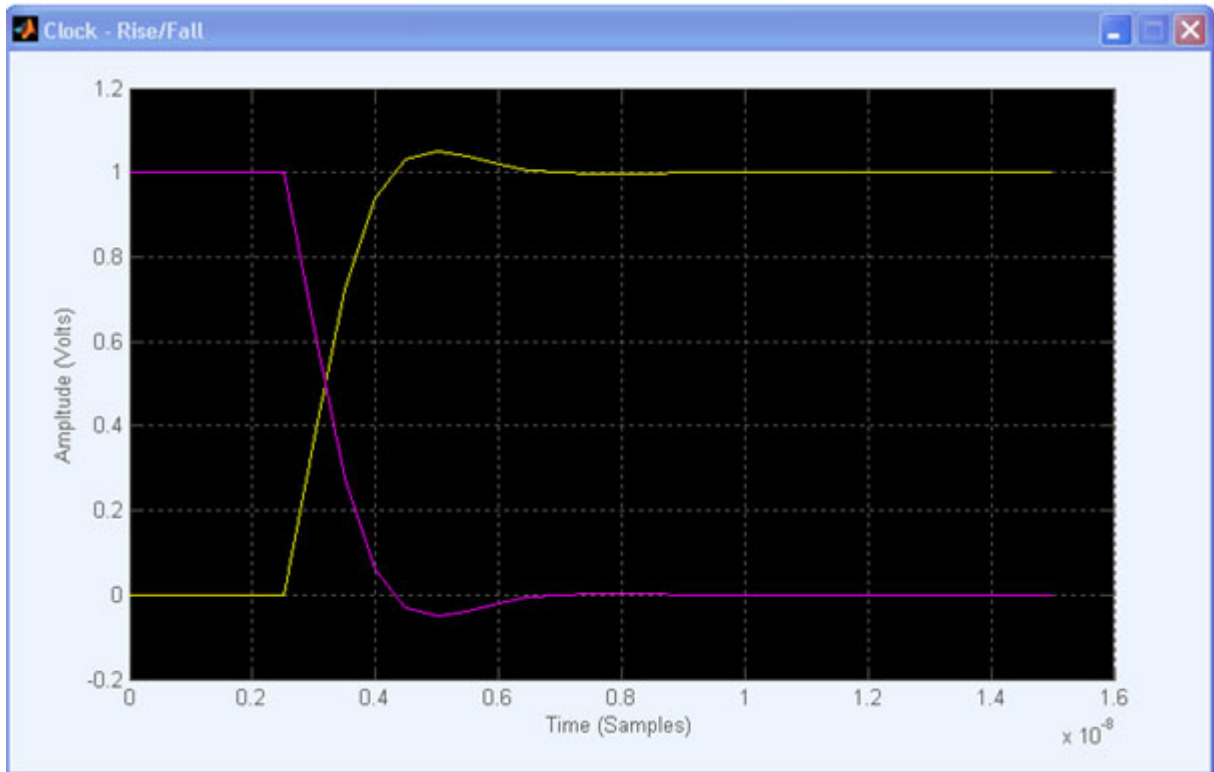

## Simulated Data Signal

The simulated data waveform graph shows the plot of Time (Samples) (X-axis) and Amplitude (Volts) (Y-axis).

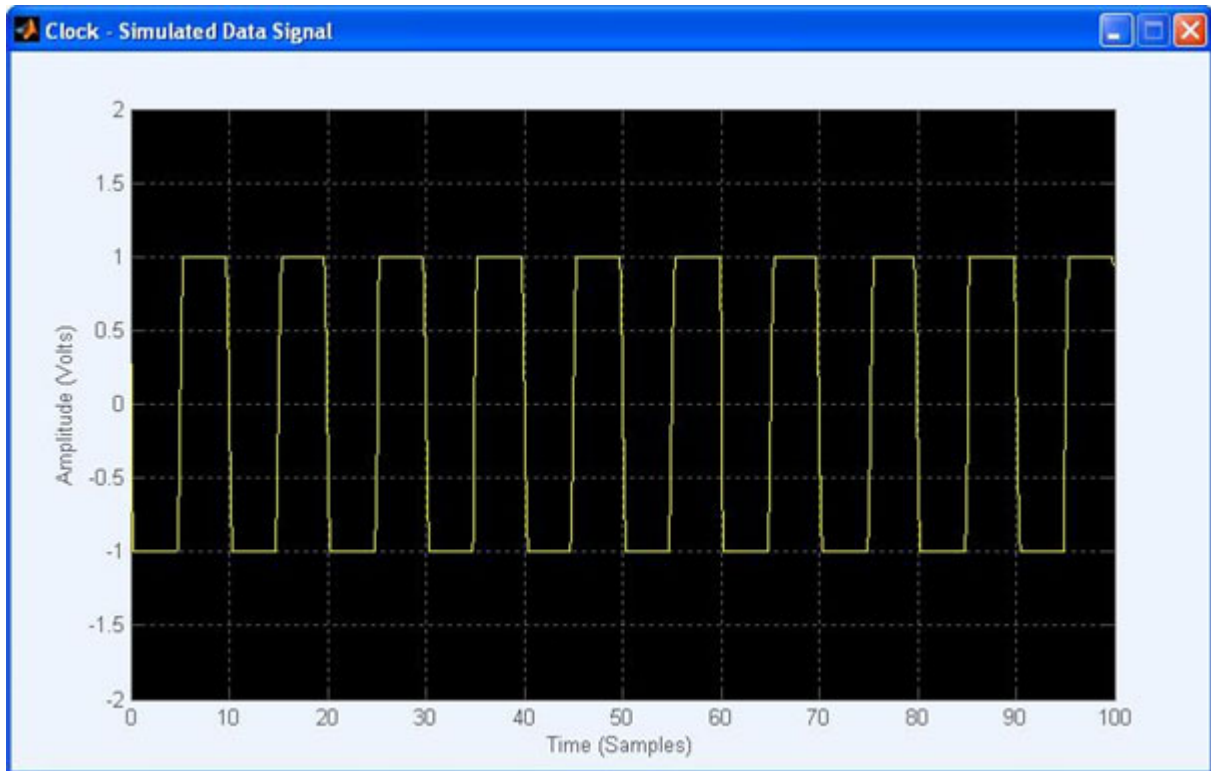

## Random Jitter

The random jitter graph shows the plot of Tie Error (ps) (X-axis) and Frequency of Occurrence (Y-axis).

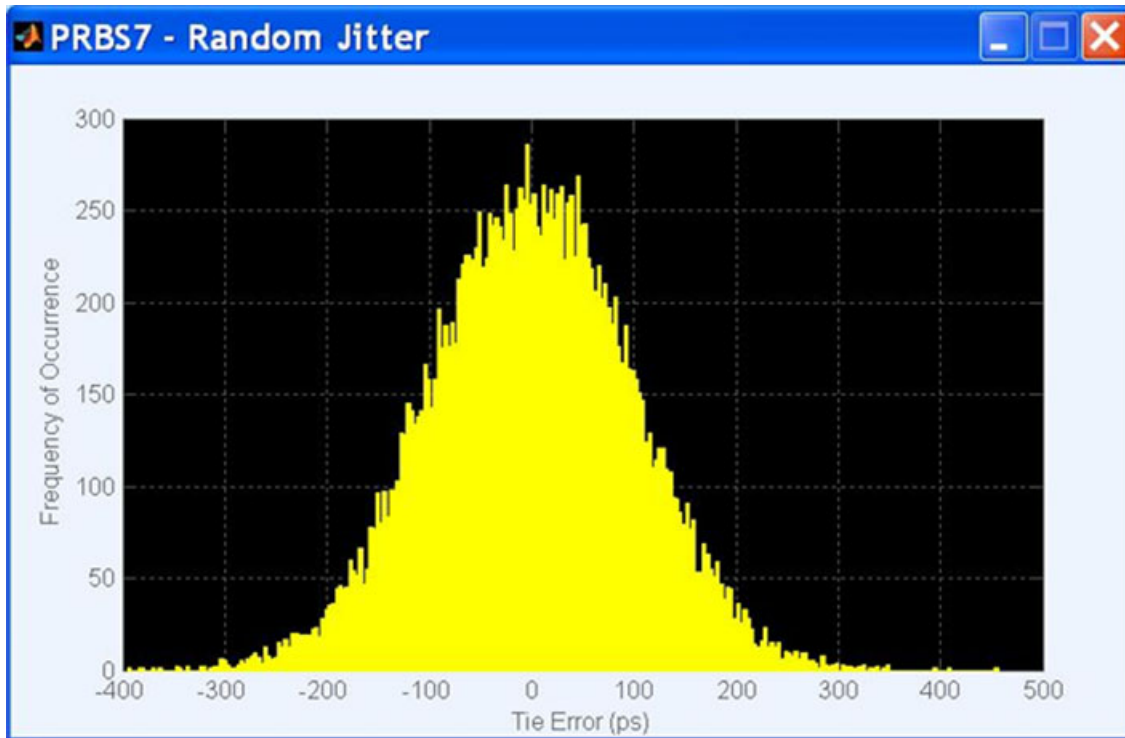

## Periodic Jitter

The periodic jitter graph shows the plot of Tie Error (ps) (X-axis) and Frequency of Occurrence (Y-axis).

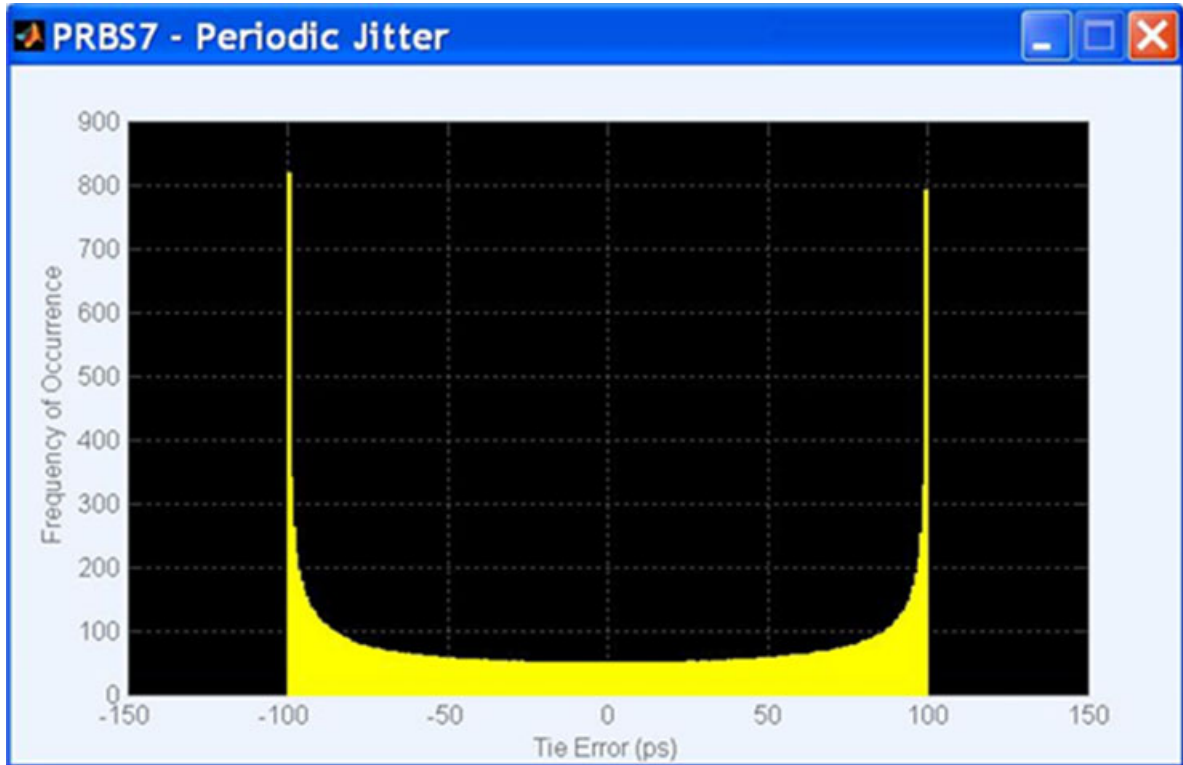

## Total Jitter

The total jitter graph shows the plot of Tie Error (ps) (X-axis) and Frequency of Occurrence (Y-axis).

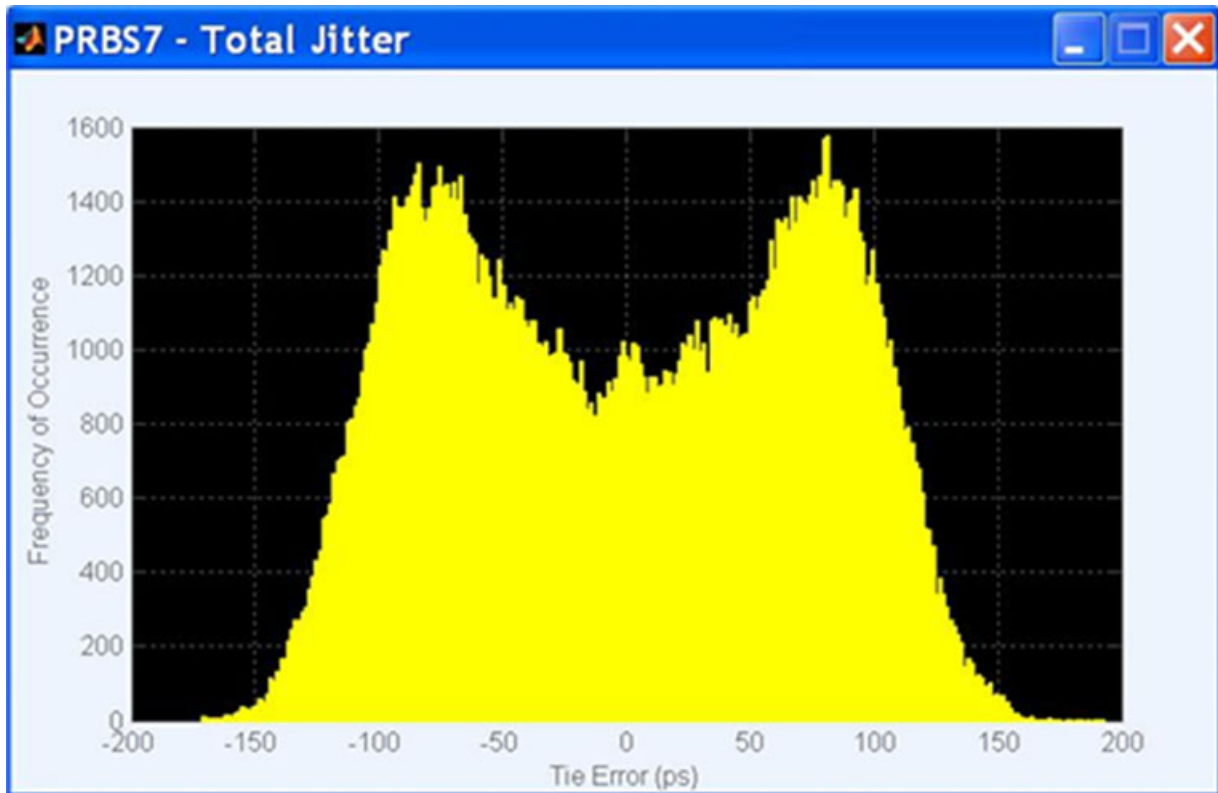



## Normal Eye

The normal eye graph shows the plot of Time (UI) (X-axis) and Amplitude (Volts) (Y-axis).

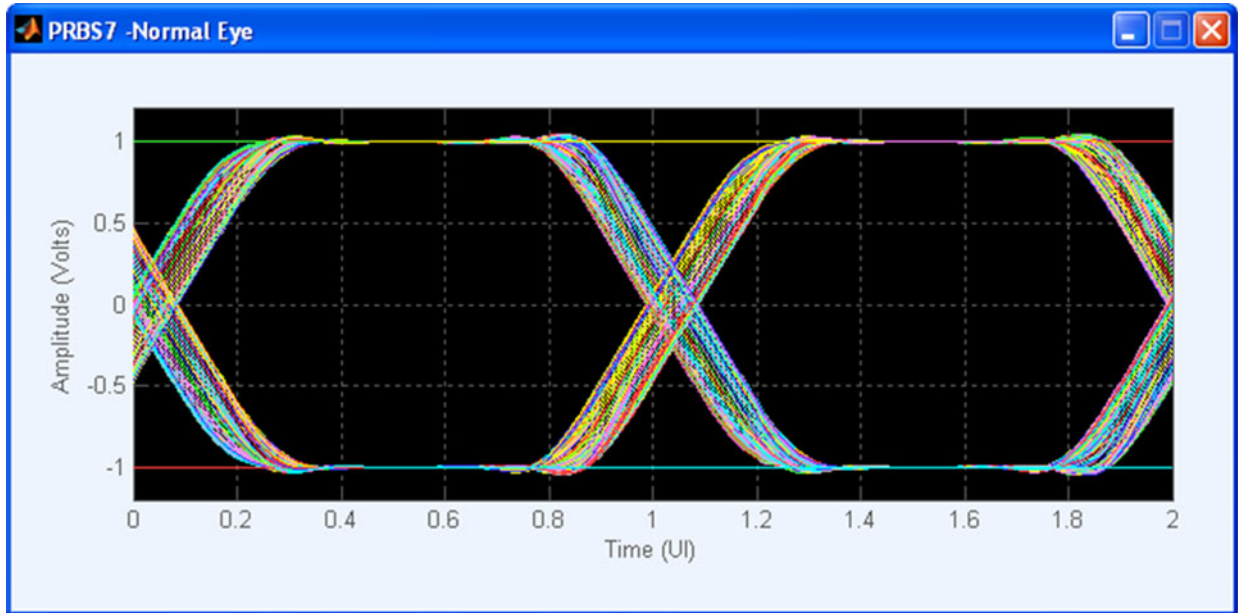

## Eye DPO

The eye DPO graph shows the plot of Time (UI) (X-axis) and Amplitude (Volts) (Y-axis).

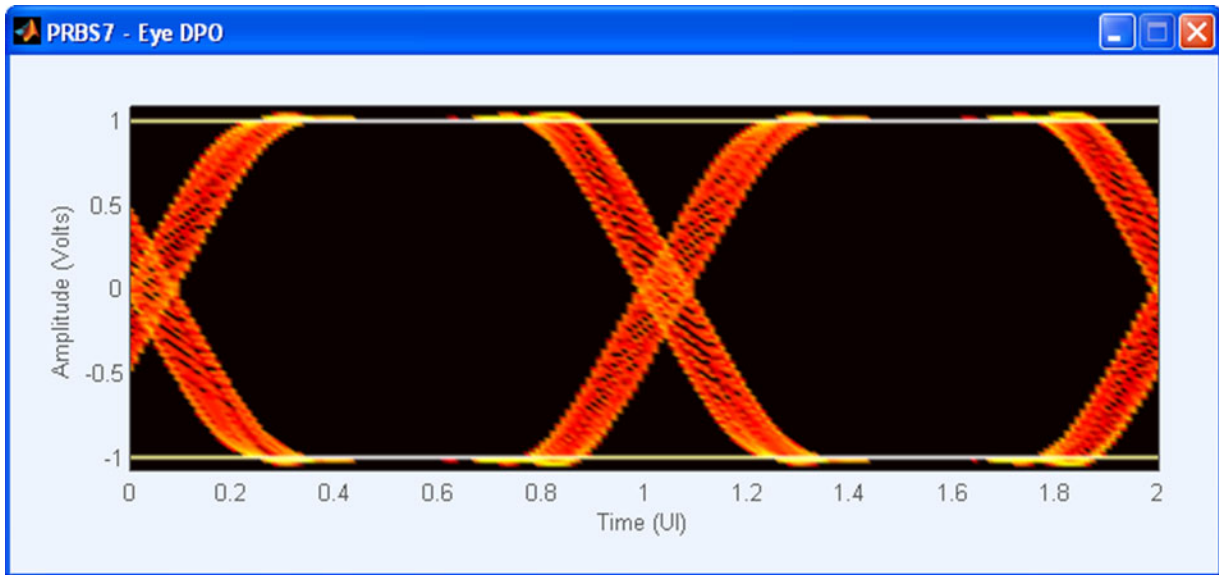

The following table shows the summary of the various jitter parameters used to create the waveform:

	UI	ps
Rj	0.050	16.667
Dj	0.000	0.000
Pj	0.000	0.000
ISI	0.000	0.000
DCD	0.000	0.000
Tj	0.700	233.333

In the Eye DPO plot, all the jitter parameters that are set in the application are shown in a table.

The total jitter is calculated using the formula  $Tj = (14 * Rj) + Dj$  where,

Tj is the Total Jitter at a specified Bit Error Rate (TJ@BER). This extrapolated value predicts a peak-to-peak jitter that will only be exceeded with a probability equal to the BER (TJ (1E-12)).

Rj is the RMS value of total Random Jitter.  $Rj = \sqrt{R_{j1}^2 + R_{j2}^2}$ , where Rj1 and Rj2 are RMS values of two independent, band limited, zero mean, and Gaussian distribution jitters.

Dj is the Deterministic Jitter, which is the sum of Periodic Jitter (Pj), Inter Symbol Interference (ISI), and Duty Cycle Distortion (DCD).

## TIE

The TIE graph shows the plot of Frequency (Hz) (X-axis) and Jitter (Secs) (Y-axis). This plot shows the raw Fast Fourier Transform (FFT) of the TIE.

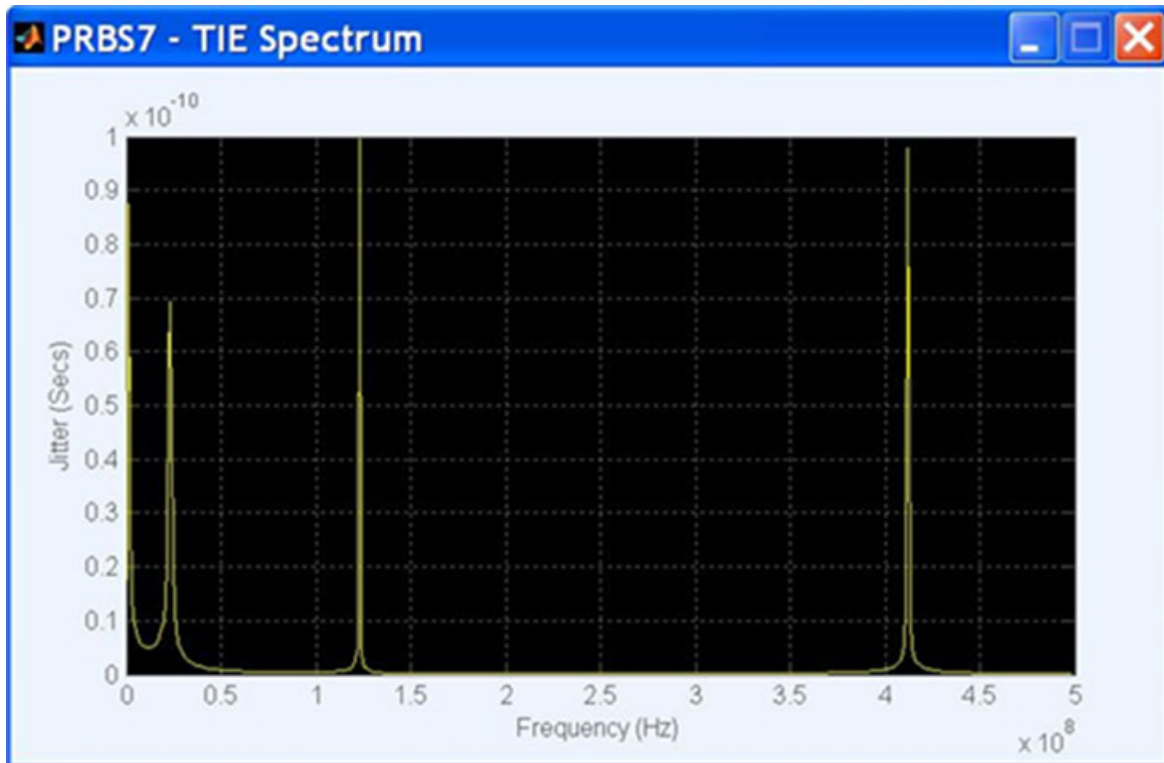



## Error Messages

The following table lists the error codes for the application.

**Table 31: Error Messages for SerialXpress**

Error message	Description	Solution
Not ready.	SerialXpress application is not ready.	Start SerialXpress.
SerialXpress instance is already running.	Second instance of SerialXpress is started.	Check task manager if the SerialXpress application is already running. If the application is running, stop that process and start SerialXpress again.
Trial period has expired. You cannot transfer and save the waveform.	The total number of trials of 10 is exceeded.	Enable the function (to transfer or save the waveform) with an option (license) key.
Invalid file name.	File name is not according to SerialXpress requirements.	Apply Microsoft Windows file naming conventions.
File does not exist.	The specified file name does not exist.	Ensure that the file path and name are correct.
Directory does not exist.	The specified directory is incorrect.	Browse the correct directory instead of entering the path.
Invalid Entry - All Ones are not allowed.	Patterns with all ones are not supported.	Enter patterns with the combination of zeroes and ones.
Invalid Entry - All Zeros are not allowed.	Patterns with all zeroes are not supported.	Enter patterns with the combination of zeroes and ones.
Unable to compile waveform.	The application fails to create the waveform.	Ensure that the base data size does not exceed 2.5 MB.
DTG file import failed.	Either the file is corrupt or DTG file format is incorrect.	Ensure that the DTG file format is correct and that the file is not corrupt.
Waveform name cannot be empty.	The waveform name is not specified.	Specify a waveform name that does not exceed 32 characters.
No selected waveform to save.	No waveform has been selected to save.	Select a waveform to save.
Waveform name specified already exists.	The same waveform name is specified.	Do one of the following: <ul style="list-style-type: none"> <li>■ Ensure that the waveform name is different.</li> <li>■ Ensure that the <b>Overwrite</b> option is enabled in the <b>Compile Settings</b> dialog box.</li> </ul>
Symbol is not valid	The symbol entered is invalid and its binary code is not defined.	Reenter a valid symbol. For valid symbol values, refer to the <i>Setting the Base Pattern</i> section. ( <a href="#">Selecting a User Pattern</a> )

Table 31: Error Messages for SerialXpress (cont.)

Error message	Description	Solution
Batch setup settings error.	The <b>Start</b> value of either Random Jitter or Periodic jitter is greater than the <b>End</b> value.	Ensure that the <b>Start</b> value is less than the <b>End</b> value in the <b>Batch Compile Setup</b> dialog box.
Both random jitter and periodic jitter are disabled. Batch compilation will generate a single waveform without any jitter.	The <b>Batch Compile Setup</b> dialog box has both Random and Periodic Jitter disabled.	Ensure that one or both Random and Periodic Jitters are enabled.
Error on parsing PRBS polynomial.	The PRBS polynomial syntax is incorrect.	Enter the correct PRBS polynomial.
Invalid file format.	File format is incorrect.	Apply valid file format.
AWG is not available.	The <b>Advanced</b> option in <b>Instrument Control</b> tab has been clicked without starting the AWG application.	Ensure that AWG application is started before starting SerialXpress.
Unauthorized access permission.	Permission not available to read a file.	Ensure that the file has read permission.
Polynomial length exceeds the maximum.	The order of the polynomial is greater than the specified value.	Ensure that the order of the polynomial is less than or equal to 18.
Unable to read or Invalid SSC custom profile file.	Either the SSC custom profile file is corrupt or file format is incorrect.	Do one of the following: <ul style="list-style-type: none"> <li>■ Ensure that the file is not corrupt.</li> <li>■ Ensure that the custom SSC profile is according to the format specified. <a href="#">Custom SSC (see page 74)</a></li> </ul>
No transition exists.	Either the input base pattern has all zeroes or all ones, or the encoding scheme is set to NRZ.	Do one of the following: <ul style="list-style-type: none"> <li>■ Enter patterns with a combination of zeroes and ones.</li> <li>■ Ensure that the encoding scheme is set to 8B10B.</li> </ul>
Setting waveform to the channel failed.	The application failed to load the waveform to the AWG channel.	Do one of the following: <ul style="list-style-type: none"> <li>■ Ensure that the waveform exists in the AWG waveform list.</li> <li>■ Ensure that the waveform size does not exceed the AWG memory limit.</li> <li>■ Ensure that the channel name is valid.</li> </ul>

Table 31: Error Messages for SerialXpress (cont.)

Error message	Description	Solution
Failed to set the sampling rate on the AWG.	The application failed to set the sampling rate on the AWG.	Do one of the following: <ul style="list-style-type: none"> <li>■ Ensure that the sampling rate is within the AWG limits.</li> <li>■ Ensure that the <b>Clock</b> is set to <b>Internal</b> and the <b>Reference</b> is set to either <b>Internal</b> or <b>External (fixed)</b>.</li> </ul>
Failed to set the output to ON for channel.	The application failed to turn the channel state to ON on the AWG.	Ensure that the channel name is valid and has a waveform loaded into it.
Failed to set the run state to ON on the AWG.	The application failed to set the run state to ON on the AWG.	Ensure that the waveforms are loaded to the AWG channels and the application is not waiting for an external trigger.
No TouchStone file selected.	The application does not have a touchstone file selected in the screen display or remote command during compilation.	Ensure that a valid touchstone file is selected in S-Parameter Filter screen display or remote command before compiling.
The physical port assigned for single-ended touchstone file is incorrect.	Same port is selected for both transmitter and receiver.	Ensure that a unique port is selected for each of the physical location.

## Shortcut Keys

Table 32: Shortcut keys

Menu/Menu item	Shortcut key
File	Alt+F
File > Open Setup...	Ctrl+O
File > Save Setup	Ctrl+S
File > Restore Default Setup	Ctrl+N
View	Alt+V
Configure	Alt+C
Waveform	Alt+W
System	Alt+S
Window	Alt+I
Help	Alt+H

## PRBS Editor Starting Values

The following table gives the initial shift register values and the PRBS polynomial expression:

**Table 33: Initial shift values and PRBS polynomial expressions**

PRBS	Shift register initial value	PRBS polynomial expression
PRBS 7	1 1 1 1 1 1 1	$X^7+X^6+1=0$
PRBS 9	1 1 1 1 1 1 1 1 1	$X^9+X^5+1=0$
PRBS 15	1 1 1 1 1 1 1 1 1 1 1 1 1 1 1	$X^{15}+X^{14}+1=0$
PRBS 16	1 1 1 1 1 1 1 1 1 1 1 1 1 1 1 1 1	$X^{16}+X^{14}+X^{13}+X^{11}+1=0$

## AWG Specifications

For information on the specifications of the AWG5000/B and AWG7000/B series instruments, refer to the following documents:

- AWG5000 Series Arbitrary Waveform Generators Specifications and Performance Verification Technical Reference, Tektronix part number 071-2082-XX.
- AWG5000B Series Arbitrary Waveform Generators Specifications and Performance Verification Technical Reference Tektronix part number 071-2486-XX.
- AWG7000 Series Arbitrary Waveform Generators Specifications and Performance Verification Technical Reference, Tektronix part number 071-1853-XX.
- AWG7000B Series Arbitrary Waveform Generators Specifications and Performance Verification Technical Reference Tektronix part number 071-2487-XX.

You can view the document by selecting **Start > All Programs > Tektronix > AWG > Documentation**.

## Interleave

The AWG7102 Option 06 supports the interleaving mode. Interleaving is a mode where the sampling rate ranges from 10 GS/s to 20 GS/s. The following table shows the amplitude and sampling rates for the interleaving and non-interleaving modes.

**Table 34: Amplitude and sampling rates in non-Interleave and interleave modes**

Non-Interleaving		Interleaving	
Amplitude (min, max)	Sampling rate (min, max)	Amplitude (min, max)	Sampling rate (min, max)
500 mVpp, 1 Vpp	10 MS/s, 10 GS/s	500 mVpp, 1 Vpp	10 GS/s, 20 GS/s



In the Interleaving mode, the output is available in a separate interleave connector as shown in the figure.

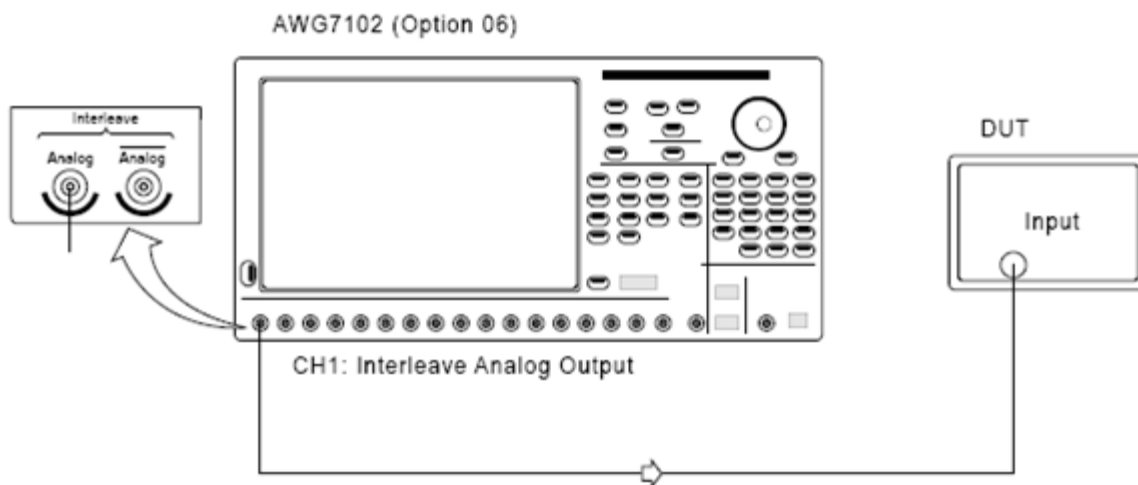

As an example, in the non-interleave mode let the sampling rate be 20 GS/s and the original amplitude samples be 0.1, 0.2, 0.3, 0.4, 0.5, 0.1, 0.2. This can be represented graphically as shown here.

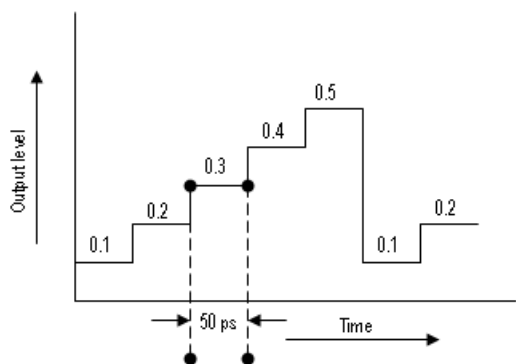

In the interleave mode, alternate samples are output from each channel. That is, the samples are distributed between the two channels as shown:

Ch1	Ch2
0.1	0.2
0.3	0.4
0.5	0.1
0.2	0

This can be represented graphically as shown.

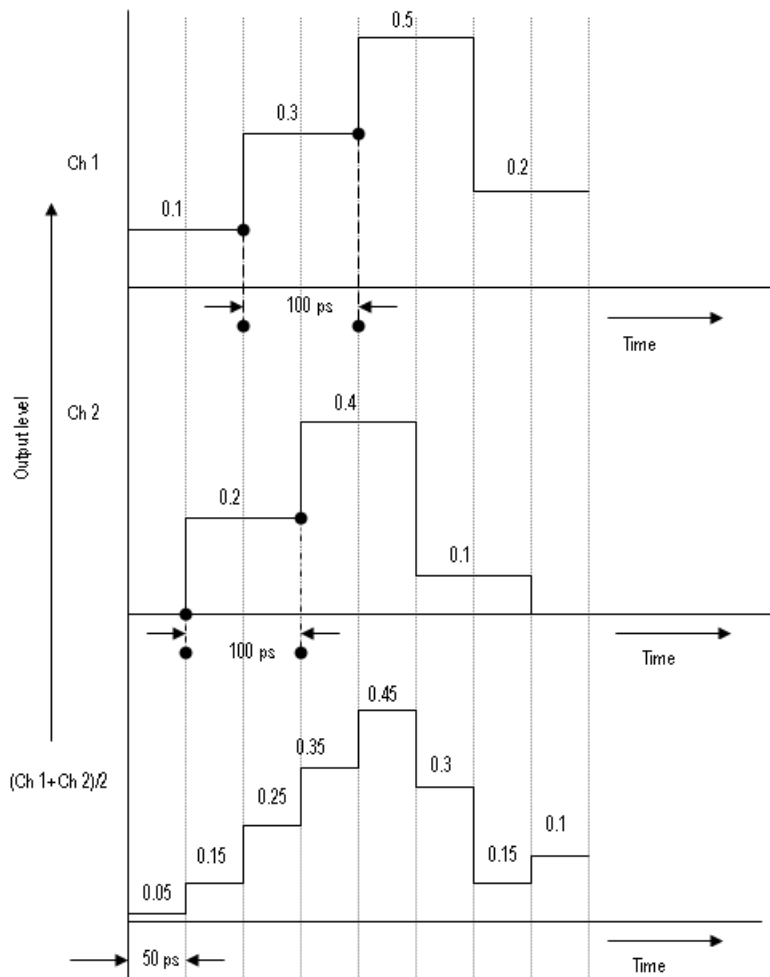

## Zeroing

When Interleave is on, you can turn Zeroing on or off to enhance the available bandwidth. This function is available only when Interleave is available. If you compose waveform data that is divided into two channels, the zeroing function allows you to select whether you want to handle each waveform as RZ (Return to Zero) or NRZ (Non Return to Zero).

If you turn the zeroing function on, the bandwidth increases. However, spurious characteristics will worsen (increase in the frequency spectra that should not be output) and the amplitude range will be halved.

## Parameter Definitions

Definitions of the jitter and time related parameters are given in the following table:

**Table 35: Jitter/Time parameters and their description**

Parameters	Description
<b>Jitter</b>	
RJ	Random Jitter is jitter that does not exhibit deterministic behavior and is not bounded. It can be described by a Gaussian probability distribution. It is characterized by standard deviation value (RMS).
PJ	Periodic Jitter is the portion of the deterministic jitter that is periodic, but for which the period is not correlated with any data in the waveform. It is measured by peak-to-peak variation and frequency.
DCD	Duty Cycle Distortion is the portion of the deterministic jitter directly correlated with waveform polarity (the difference in the positive edges and negative edges).
Noise	This is a type of additive <a href="#">white noise (see page 77)</a> that modifies the vertical amplitude of the serial data and contributes to the jitter.
<b>Time</b>	
Rise Time	Elapsed time between the low reference level crossing and the high reference level crossing on the rising edge of the waveform. It is measured in time units between the 10% and 90% levels or between the 20% and 80% levels.
Fall Time	Elapsed time between the high reference level crossing and the low reference level crossing on the falling edge of the waveform. It is measured in time units between the 10% and 90% levels or between the 20% and 80% levels.

## About Calibration

SerialXpress creates pre-distorted waveforms with precise amount of distortion. The types of distortion can include random jitter, ISI, and others. The AWG generates these waveforms from the SerialXpress and transmits them to the DUT through a cable. These generated waveforms are measured on the oscilloscope. If the resulting waveform is not as expected, it could be due to distortion caused by either inherent jitter within the AWG or the characteristics of the transmitting cable. Calibration minimizes the errors in random jitter.

Calibration is performed on a specific AWG, oscilloscope, and associated cable and fixtures with a defined sampling rate and data rate. Changes in any of these requires recalibration.

Error is the deviation between the expected result and the actual result.

The calibration data is saved as `sxc` file.

`sxc` is a custom format binary file which includes correction information on `Rj` and `Pj`.

## About Spread Spectrum Clocking (SSC)

Spread Spectrum Clocking (SSC) is the technique of modulating the clock frequency to minimize electro magnetic induction (EMI) effects. SSC is generated with a profiles having a frequency and frequency deviation. The frequency deviation is specified in ppm. The available SSC profiles are sinusoidal, triangle, and custom.

---

**NOTE.** *To generate integer cycles of the SSC profile, the software may alter the frequency of the SSC to meet the memory requirements of the instrument.*

---

### Custom SSC

The custom SSC profile is a comma separated file with the extension `csv`.

The format of the custom SSC is as follows:

```
<time>,<ppm><cr><lf>
```

```
<time>,<ppm><cr><lf>
```

```
.....
```

```
.....
```

The first column represents time and the second column represents deviation in ppm.

where,

`<cr>` refers to carriage return.

`<lf>` refers to line feed.

## About Inter Symbol Interference (ISI)/ISI Scaling

Inter Symbol Interference (ISI) is generated due to the limited bandwidth of the channel. The following are the two ways to generate ISI:

**Method 1:** Using digital filter to simulate the effect of ISI by directly entering the ISI value in the **Channel/Cable** tab

When ISI is 0, the waveform is undistorted.

When ISI is greater than 0, the waveform is distorted. As the value of ISI increases, the distortion increases.

**Method 2:** Using S-Parameter filter and ISI scaling

The S-Parameter files contains the values of the specific devices used to connect the DUT. When you select an S-Parameter file, the corresponding values of the device are applied to the waveform causing distortion. If you use the cable of the corresponding S-Parameter file instead of the S-Parameter file, the same output is obtained at the DUT.

---

**NOTE.** *ISI scaling is enabled only when you select S-Parameter Filter.*

---

When ISI scaling is 0, the effect of ISI is not seen and the waveform is undistorted.

When ISI scaling is in the range 0–1, the effect of ISI gradually increases. At 1, the effect of ISI is completely introduced thereby causing a distorted waveform.

When ISI scaling is in the range 1–10, the effect of ISI will further increase.

You can see the effect of ISI in the Eye DPO plot and the Data Dependent Jitter (DDJ) can be measured on the oscilloscope. As the data rate and the sampling rate increase, the effect of ISI increases.

## DPOJet Settings

You can do calibration in two ways: Automatic and Manual.

### Automatic

Use the automatic method when SSC is not available in the signal.

Do the following to set up the DPOJet application on the connected oscilloscope:

1. In the SerialXpress application, set the Base Pattern and Compile Settings parameters for calibration.
2. Select **Calibration** from the toolbar.
3. From the list of instruments, highlight an oscilloscope and click **Connect**.
4. In the Calibration Setup group, set the DPOJet Settings to **Automatic**. The following message is displayed:

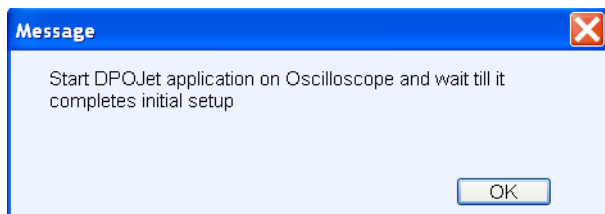

5. On the oscilloscope, click **Default Setup** and **Autoset** to check if the signal is available.

6. Select **Analyze > Jitter & Eye Analysis > Wizard > One Touch Jitter**.  
DPOJet automatically configures various parameters for optimum performance.
7. In the SerialXpress application, click **OK** in the message box to proceed with calibration.

## Manual

Use the manual method to measure SSC.

Do the following to set up the DPOJet application on the connected oscilloscope:

1. In the SerialXpress application, set the Base Pattern and Compile Settings parameters for calibration.
2. Select **Calibration** from the toolbar.
3. From the list of instruments, highlight an oscilloscope and click **Connect**.
4. In the Calibration Setup group, set the DPOJet Settings to **Manual**.
5. Set the path and file name to create the correction file and select **Apply Calibration**.
6. Click **Calibrate**. The following message is displayed:

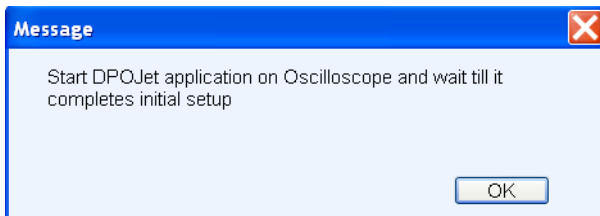

7. On the oscilloscope, perform the following steps:
  - Click **Default Setup** and **Autoset** on the oscilloscope front panel.
  - Select **Analyze > Jitter & Eye Analysis > Wizard > One Touch Jitter**.
  - Set the required record length.
8. In the SerialXpress application, click **OK** in the message box to proceed with calibration. The following message is displayed:

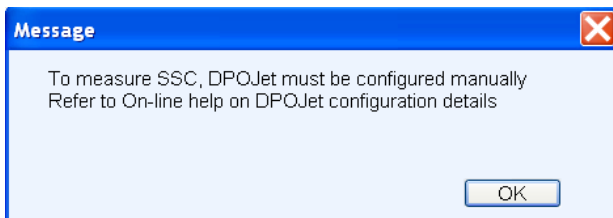

9. Configure all the DPOJet parameters manually.

10. In the SerialXpress application, click **OK** in the message box to proceed with calibration.

---

**NOTE.** *During calibration, if a warning or an error message appears in the DPOJet application, SerialXpress will not yield correct results.*

---

## White Noise

SerialXpress supports white Gaussian distribution. Since the noise is generated in the digital domain, the Gaussian distribution is spectrally flat and is half the sampling frequency. The amplitude of this noise can be controlled. The noise generated is independent for each compilation.

### Limitation of pattern length on randomness

The noise is created as part of the waveform data. Due to AWG memory limitations, the waveform data has finite length. This limits randomness of the noise. The larger the waveform length, the greater is the randomness of the noise. The AWG supports waveforms up to 64 M samples and hence the noise is random upto this limit. For waveforms greater than 64 M samples, the noise pattern repeats. This limitation of the AWG pattern length applies to random jitter.

### Impact of noise on a differential waveform

When noise is added to a differential waveform, its amplitude appears doubled. This is because the noise is generated in the application and appears as a waveform output for AWG.

## Periodic Jitter - Sample Test Results

The maximum value of periodic jitter that can be set in the **Transmitter** tab for various combinations of data rate and frequency is as follows:

Table 36: Periodic jitter maximum values

Data Rate	Frequency of Periodic Jitter								
	100 kHz	500 kHz	1 MHz	10 MHz	20 MHz	40 MHz	80 MHz	100 MHz	500 MHz
	<b>Periodic Jitter (Pk-Pk)</b>								
0.5 Gb/s	50 UI	30 UI	18 UI	10 UI	6 UI	2 UI	1 UI	0.25 UI	-
1 Gb/s	50 UI	35 UI	25 UI	15 UI	10 UI	6 UI	2 UI	1 UI	-
2 Gb/s	50 UI	40 UI	35 UI	20 UI	15 UI	10 UI	4 UI	1 UI	1 UI
3 Gb/s	50 UI	50 UI	40 UI	30 UI	20 UI	12 UI	6 UI	2 UI	1 UI
4 Gb/s	50 UI	50 UI	50 UI	40 UI	30 UI	15 UI	8 UI	2 UI	1 UI
5 Gb/s	50 UI	50 UI	50 UI	45 UI	35 UI	16 UI	8 UI	4 UI	1 UI
6 Gb/s	50 UI	50 UI	50 UI	50 UI	40 UI	20 UI	12 UI	4 UI	1 UI

## Main Menu Default States

Table 37: Default states and selection

Item	Options	Default state
<b>Menu Bar</b>		
<b>File</b>	Restore Default Setup	Always enabled
	Open Setup...	Always enabled
	Save Setup	Always enabled
	Save Setup As...	Always enabled
	Import from File...	Always enabled
	Import from Tektronix Oscilloscope...	Always enabled
	Save Data As...	Enabled when a waveform is available in the Waveform List.
	Exit	Always enabled
<b>View</b>	Standard Toolbar	Always enabled
	Status Bar	Always enabled
<b>Configure</b>	Find Instruments...	Always enabled
<b>Waveform</b>	Compile	Always enabled except when the compilation is in progress.
	Compile Settings...	Always enabled
	Graph Setup...	Always enabled



Table 37: Default states and selection (cont.)

Item	Options	Default state
<b>System</b>	Run	Enabled when SerialXpress is running in the online mode.
	Stop	Enabled when SerialXpress is running in the online mode.
	All Outputs On/Off	Enabled when SerialXpress is running in the online mode.
	Calibration...	Always enabled
	Option Installation	Always enabled
<b>Window</b>	Waveform List	Always enabled
	Graph	Always enabled
	Instrument Control	Always enabled
	Overview	Always enabled
	Close All	Always enabled
<b>Help</b>	Help Topics...	Always enabled
	Technical Support...	Always enabled
	About SerialXpress...	Always enabled
<b>Toolbar</b>		
Calibration	-	Always enabled
Overview	-	Always enabled
Find instruments	-	Always enabled
Graph Setup	-	Always enabled
Compile	-	Always enabled except when compilation is in progress.
Compile Settings	-	Always enabled
Batch Setup	-	Always enabled
On/Off	-	Enabled when SerialXpress is running in the online mode.
Run	-	Enabled when SerialXpress is running in the online mode.

## Default Values

Table 38: Default values and selection

Item	Option	Range/selection	Default value/selection
<b>Base Pattern tab</b>			
Base Pattern	Standard	SATA, SAS, HDMI, Display Port, PCI-Express, Fiber Channel, General, and USB	General
	Pattern	Selections are different for different patterns	Clock
	From File	-	Disabled
	User Pattern	-	Disabled
Signal	Data Rate	500 Kb/s to 6 Gb/s (AWG7000B without interleave) 500 Kb/s to 12.0 Gb/s (AWG7000B with interleave) 500 Kb/s to 3300 Mbps (AWG5000) 500 Kb/s to 12 Gb/s (Offline)	1 Gb/s
	Idle State	53 ns to 100 $\mu$ s	320 ns
Amplitude	Maximum	+0.5 V to -0.25 V	+0.5 V (Offline) Depends on the maximum amplitude value of the AWG (Online)
	Minimum	+0.25 V to -0.5 V	-0.5 V (Offline) Depends on the maximum amplitude value of the AWG (Online)
Encoding	Scheme	NONE (NRZ) or NRZI	NONE (NRZ)
	8B10B	Enabled or Disabled	Disabled
	Disparity	RD+ or RD-	RD+
Rise/Fall	Rise/Fall Time	10/90 or 20/80	10/90
	DCD	0 UI to 1 UI	0 UI
	Rise	0.6/sampling rate to 0.6/data rate	100 ps
	Fall	0.6/sampling rate to 0.6/data rate	100 ps
<b>Transmitter tab</b>			

**Table 38: Default values and selection (cont.)**

Item	Option	Range/selection	Default value/selection
Periodic Jitter	Magnitude	0 UI to 50 UI	0 UI
	Frequency	10 kHz to Data rate/2	10 MHz
	Phase	0 ° to 360 °	0 °
Random Jitter	Random Seed	1 to 99999	12345
	Magnitude	0 UI to 0.5 UI	0 UI
	Frequency-Low (Hz)	1 Hz to (Frequency-High – 1 M)	100 kHz
	Frequency-High (Hz)	1.1 MHz to Data rate/2	Data rate/2
SSC	Shape	Sine, Triangle, Custom	Triangle
	Spread	Up, Down, Center, Unequal	Down
	Unequal Spread	0% to 100%	0%
	Minimum Duration	0 μs to 5 μs	0 μs
	Location	20% to 80%	50%
	df/dt	0 ppm/μ to 5000 ppm/μs	0 ppm/μs
	Frequency Deviation	0 ppm to 200000 ppm	4000 ppm
	Frequency Modulation	10 kHz to 500 kHz	33 kHz
Noise	-	0 Volt (RMS) to 0.5 Volt (RMS)	0 Volt (RMS)
Pre-emphasis	-	0 dB to 20 dB	0 dB
Add Noise At	-	Near end or far end	Near end
<b>Channel/Cable tab</b>			
ISI	-	0 UI to 1 UI	0 UI
S-Parameter Filter	Read from File	-	s4p
	Inverse Filter	Enabled or Disabled	Disabled
	ISI Scaling	0 to 10	1



# Index

## Symbols and Numbers

8B10B, 35

## A

Amplitude

- maximum, 39
- minimum, 39

Application

- basic operations, 7
- exiting, 9
- installation, 4
- ordering, 3
- overview, 8
- starting, 9
- system requirements, 3

Arbitrary waveform generator (AWG)

- control, 51
- specifications, 70

Automatic, 25

## B

Bandwidth expansion filter, 25

Base data

- calibration, 43
- creating calibration data, 44
- creation, 40
- settings, 35
- setup for signal generation, 4

Base pattern tab, 35

Batch process, 26

## C

Calibration, 18

Calibration setup, 18

Channel/Cable tab  
settings, 48

Compile button preferences, 25

Conventions, 1

## D

Data rate, 38

- default values for various standards, 38

DCD, 40

Default values, 80

Delete

- waveform, 17

df/dt, 46

- Location, 46

- Minimum duration, 46

Differential, 50

Directories, 10

Disparity, 39

DPOJet Settings, 75

- Automatic, 75

- Manual, 76

Duty cycle distortion, 73

## E

Encoding scheme, 35

Error messages, 67

Eye DPO, 64

## F

Fall time, 40

Far end, 47

Feedback, 2

File format

- 10-bit data, 42

- 8-bit data, 41

- Symbol data, 42

File name extensions, 10

Free trial, 1

Frequency

- Deviation, 46

- Modulation, 46

## G

Graphs

- types, 57
- zooming, 57

## I

Idle state, 38

- waveforms, 38

Import from Tektronix

- oscilloscope, 31

Importing data from a file, 31

Instrument setup, 18

Instruments

- control, 54

Inter symbol interference (ISI), 48

Interleave, 70

Inverse filter, 48

ISI scaling, 48

## J

Jitter parameters

- settings, 45

Jitter summary, 64

## K

Key features, 8

## M

Main menu default states, 78

Marker settings, 26

Menu bar, 11

- Configure, 13

- File, 11

- Help, 15

- System, 14

- View, 13

- Waveform, 13

- Window, 14

## N

Near end, 47

Noise, 47

- white noise, 73

Normal eye, 63

**O**

- Open setup, 31
- Option
  - software, 3
- Option installation
  - license key, 29
- Oscilloscope
  - connect and control, 54

**P**

- Parameters
  - definition, 73
- Periodic jitter, 28
- PRBS editor, 33
  - starting values, 70
- Pre/De-emphasis, 47

**R**

- Random jitter, 73
- Read from file, 48
- Related documentation, 1
- Rename
  - waveform, 17
- Repetition count, 25
  - Automatic, 25
  - Manual, 25
- Restore default setup, 30
- Rise time, 73
- Rise/Fall, 58

**S**

- S-Parameter, 48
  - four-port, 49
  - one-port, 48
  - two-port, 48
- Safety Summary, v
- Save data as, 17
- Save setup, 31
- Save setup as, 31
- Send to AWG, 17
- Shape, 46
- Shortcut keys, 69
- Show graph, 17
- Signal
  - Patterns, 35
  - Standards, 35
- Simulated data signal, 59
- Sine 1, 28
- Single-ended, 49
- Spread, 46
- Spread spectrum clocking (SSC), 74
  - Custom, 74
- Status bar, 16
  - offline mode, 16
  - online mode, 16

**T**

- TIE, 65

**Toolbar, 15**

- Batch setup, 26
- Calibration, 18
- Compile, 23
- Compile settings, 23
- Find Instruments, 21
- Graph setup, 21
- On/Off, 29
- Overview, 20
- Run, 29
- Total jitter, 62
- Transmitter tab, 45

**U**

- Unequal spread, 46
- User pattern, 37
  - Binary, 37
  - Hex, 37
  - Symbol, 37

**W**

- Waveform list, 16
- White noise, 77

**Z**

- Zeroing, 72